

# GST – Cross border transactions including SEZ, EOU and FTWZ



By CA Tushar Aggarwal



**TATTVAM ADVISORS**  
Tax Consultants





## Basic Provision

Import and Export of Goods and Services.  
Zero Rated Supplies



## Case Studies: Goods

Import of Goods on lease, Import of Goods for Job worker, Bill to India – Ship to Outside India, Revision of prices in case of Export, Schedule III Transactions, Duty Free Shops



## Case Studies: Services

Ocean Freight under CIF, ECB charges paid to Foreign Bank, Intermediary Services (Investment Advisory Services, Promotion Services), Immovable Property. Testing Services, etc.



## Specific Transactions

HO/BO/LO Transactions  
Airline Industry  
Cross Border Transportation of Goods  
Software Industry

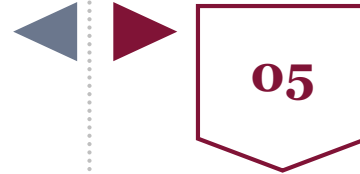

## SEZ/EOU/FTWZ

SEZ: Import, Export, DTA purchase/ sale, RCM  
EOU: Export, Import, DTA purchase  
FTWZ: Supply to/by FTWZ

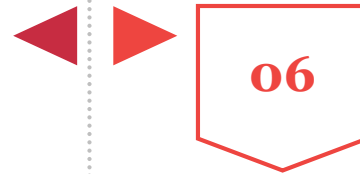

## Question and Answer



# Basic Provision

---



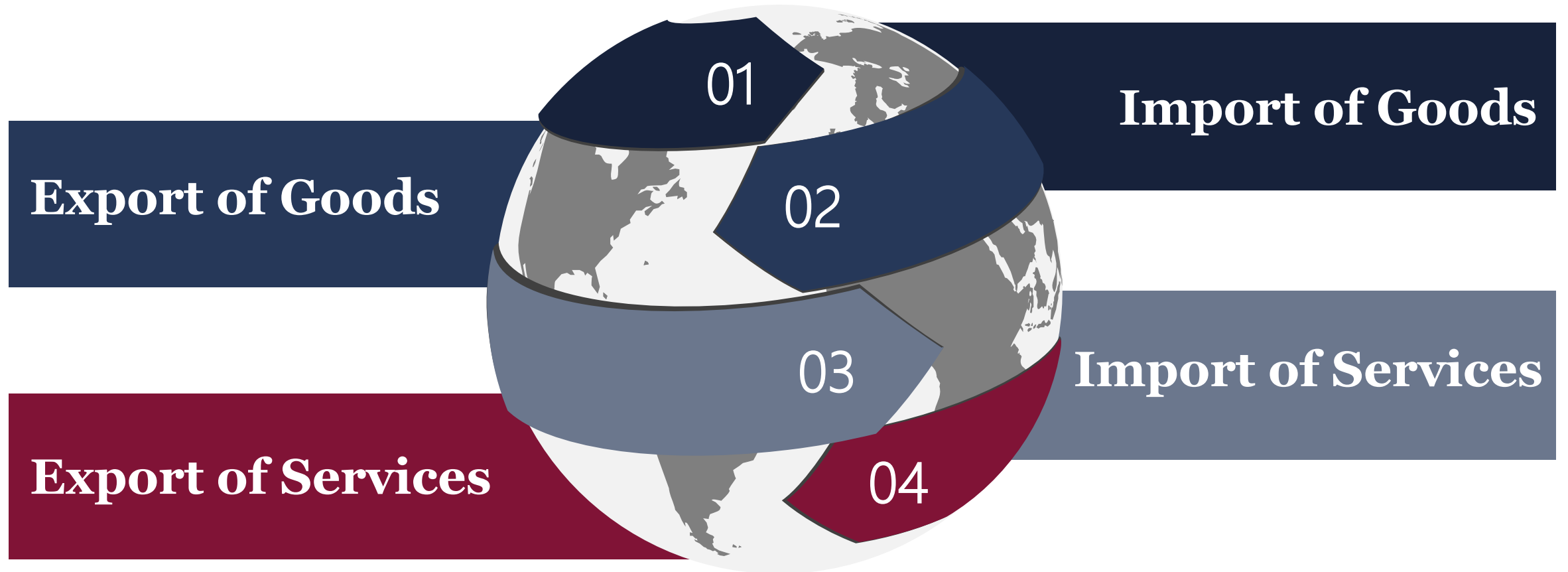

# Goods: Import and Export

## **Import of Goods [S 2(10)]**

*Bringing goods into India from a place outside India*

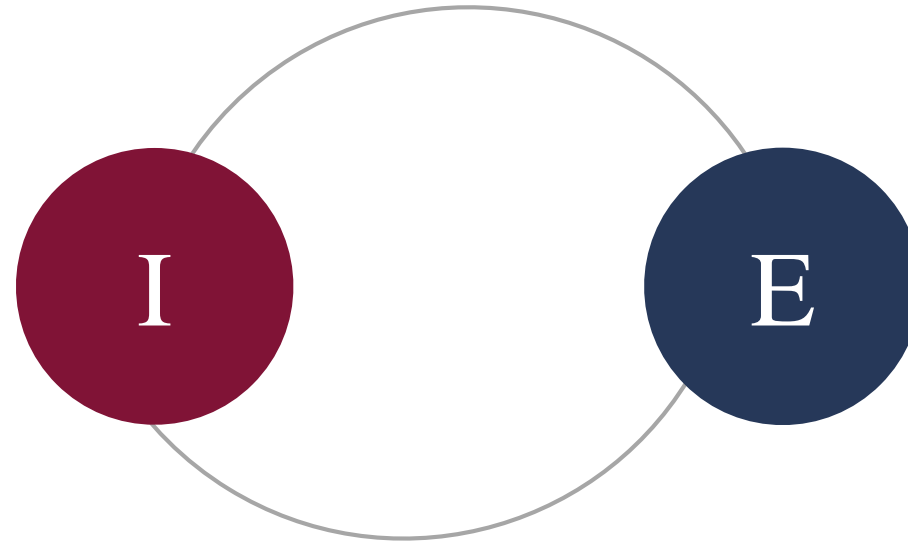

## **Export of Goods [S 2(5)]**

*Taking goods out of India to a place outside India*

# Inter state Supply – Section 7

**Section 7(2)** – Supply of **goods** imported into the territory of India, till they cross the customs frontiers of India, shall be treated to be a supply of goods in the course of inter-State trade or commerce

“customs frontiers of India” means the limits of a customs area as defined in section 2 of the Customs Act, 1962

**Section 2(11) of Customs act, 1962 “Customs area”** means the area of a customs station or a warehouse and includes any area in which imported goods or export goods are ordinarily kept before clearance by Customs Authorities;

**Section 7(4)** – Supply of **services** imported into the territory of India shall be treated to be a supply of services in the course of inter-State trade or commerce.

Inter state Transaction

Goods purchased from USA by `a trader in Maharashtra



## Import of Services [S. 2(11)]

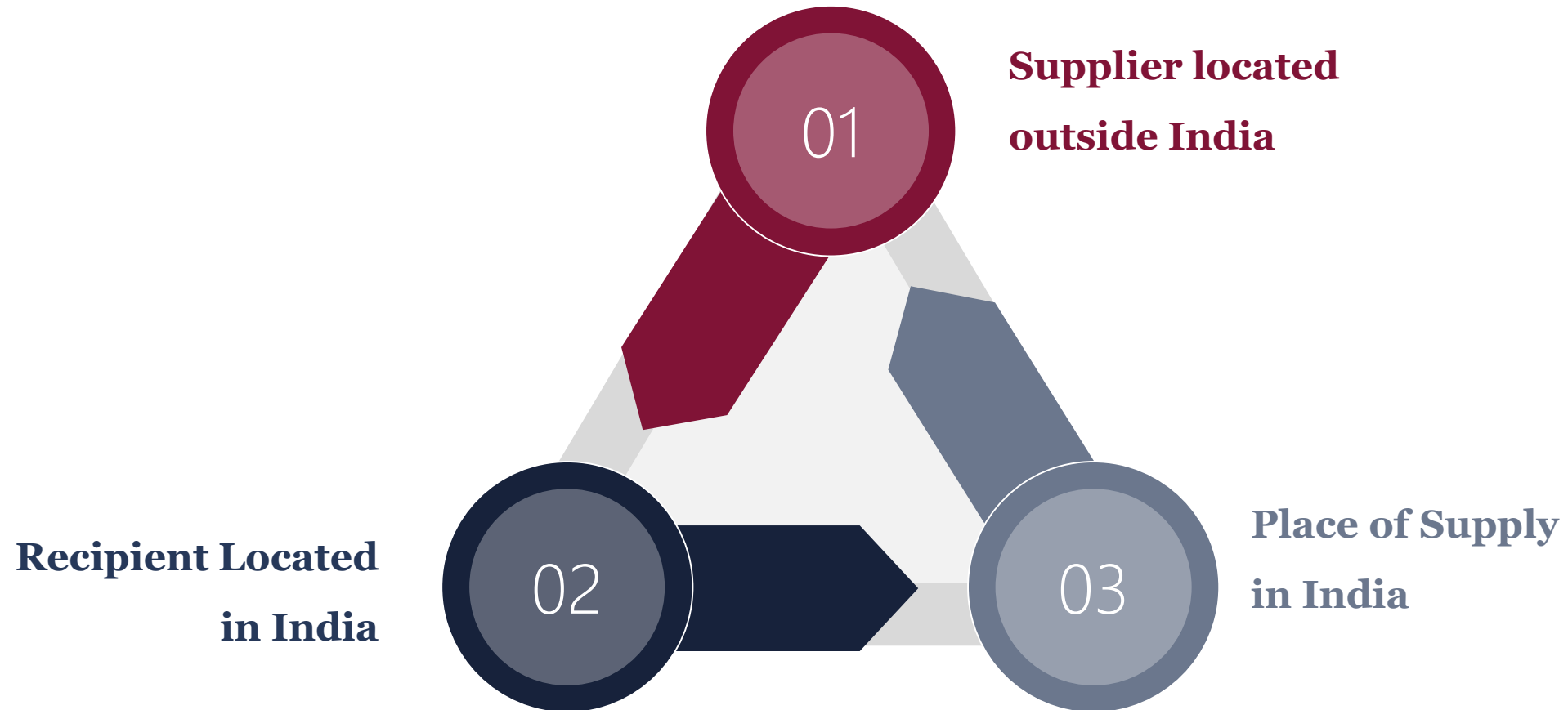

## Export of Services [S. 2(6)]

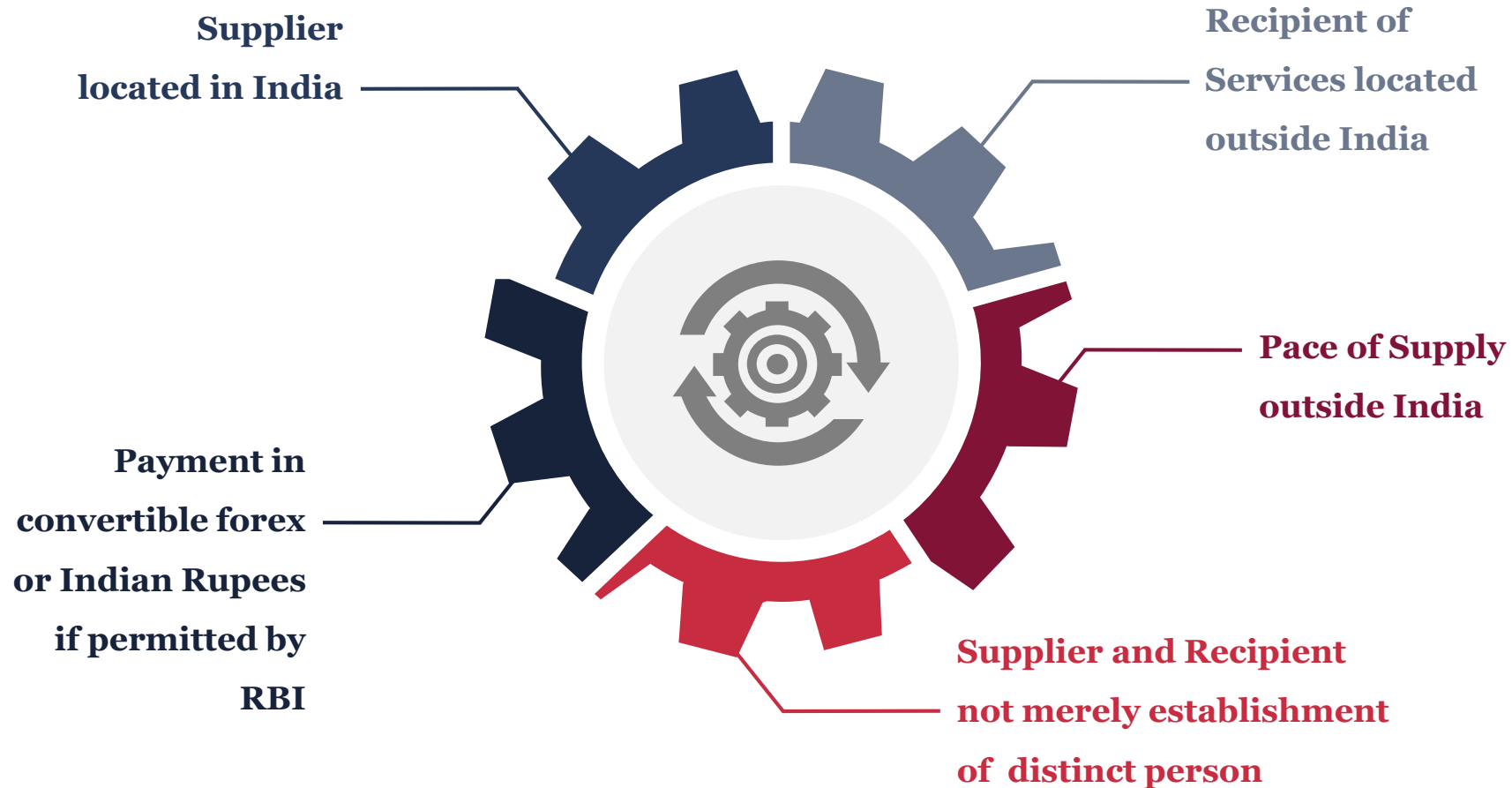



## What is Zero-rated supply

- Export of goods or **services** or both
- Supply of goods or services or both to a Special Economic Zone developer or a Special Economic Zone unit

## Benefits of Zero-rated supply

- Supply goods or services under LUT/Bond and claim refund of unutilized ITC
- Supply goods or services on payment of IGST and claim refund of IGST paid



# Case Studies - Goods

---



Tattvam Advisors Copyright

# Case Study 1 - Import of Goods on Lease Basis

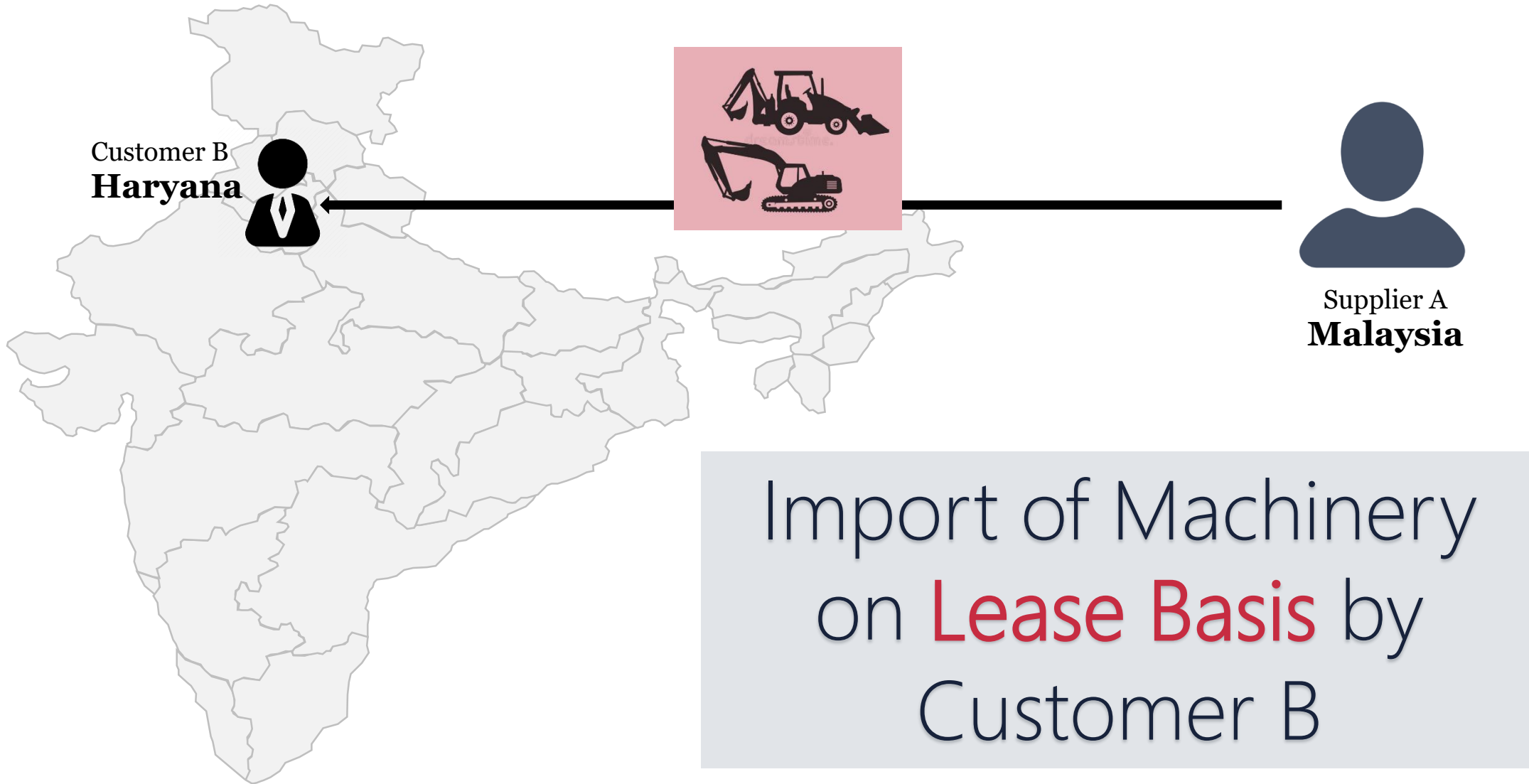

## **IGST Act, 2017 [Proviso to Section 5]**

*Provided that the integrated tax on goods imported into India shall be levied and collected in accordance with the provisions of section 3 of the Customs Tariff Act, 1975 on the value as determined under the said Act at the point when duties of customs are levied on the said goods under section 12 of the Customs Act, 1962.*

## **Customs Tariff Act, 1975 [ Section 3(7)]**

*Any article which is imported into India shall, in addition, be liable to integrated tax at such rate, not exceeding forty per cent. as is leviable under section 5 of the Integrated Goods and Services Tax Act, 2017 on a like article on its supply in India, on the value of the imported article as determined under sub-section (8) 8[or sub-section (8A), as the case may be.*

# Case Study 1 - Import of Goods on Lease Basis

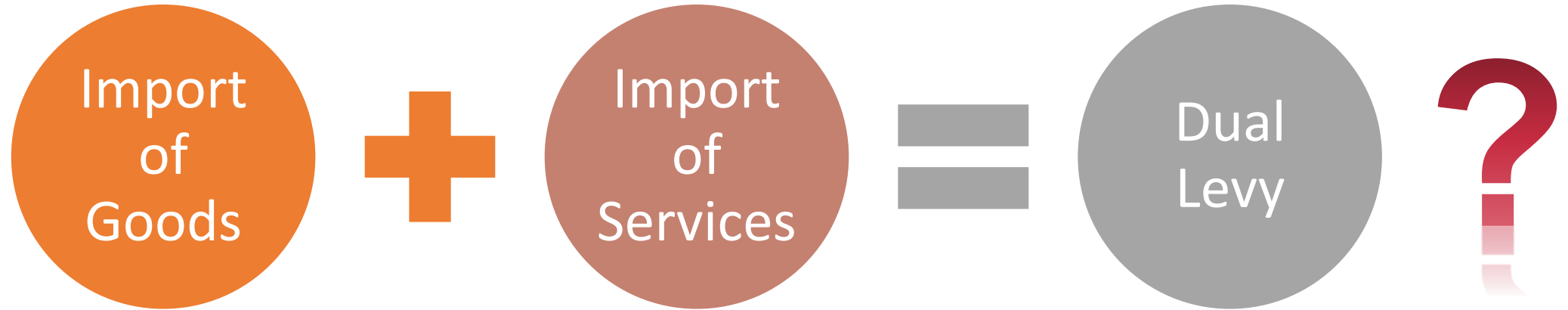

**Bringing goods into India  
from a place outside India**

- **Supplier located outside India**
- **Recipient located in India**
- **Place of Supply in India**

## Notification No. 50/2017-Custom

### Schedule II transaction

- Transfer of right or of undivided share in goods without the transfer of title
- Transfer of the right to use any goods for any purpose (whether or not for a specified period) for cash, deferred payment or other valuable consideration.

### Goods Imported

- Aircrafts, aircraft engines and other aircraft parts [S. No. 547A]
- Rigs and ancillary items imported for oil or gas exploration and production [S. No. 557A]
- All goods, vessels, ships (other than motor vehicles) [S. No. 557B]

### Condition with Bond

- Pay IGST on import of services
- Not to sell or part without prior permission
- To re-export within 3 months of the expiry of lease
- Pay IGST on import of goods for violation of any of the above conditions

**Whether levy of GST on import of Goods is under Custom Act or IGST Act?**

**Whether BCD levied by Custom Act can be challenged?**

**Whether exemption under IGST Act is also required?**

**Whether re-export is a supply under GST?**

**Can taxpayer challenge dual levy if conditions are not being fulfilled?**

**Whether drawback is eligible when goods are re-exported?**

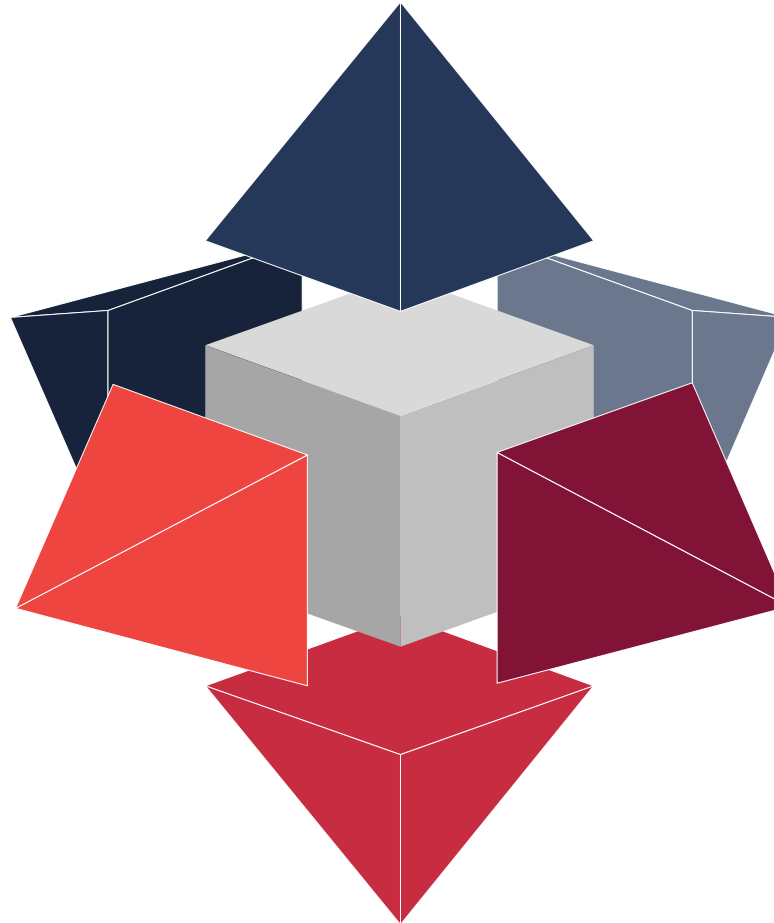

## International Border

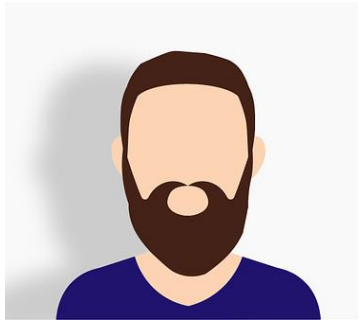

Customer located in  
Malaysia

BOE filed by Job  
Worker



Goods returned after  
job work process

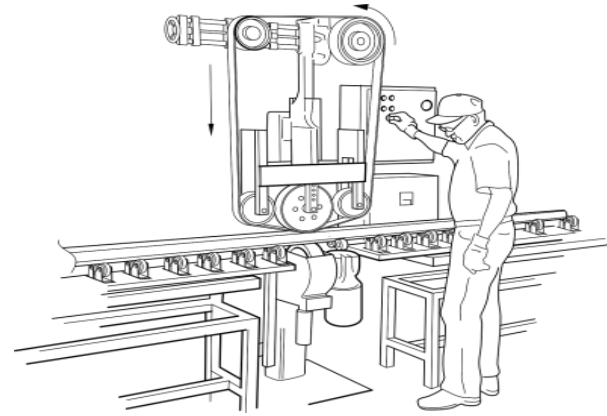
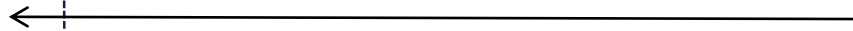

Job Worker Maharashtra

- IGST paid by job worker on goods sent by customer located in Malaysia
- Input tax of IGST paid not available and becomes cost for the job worker



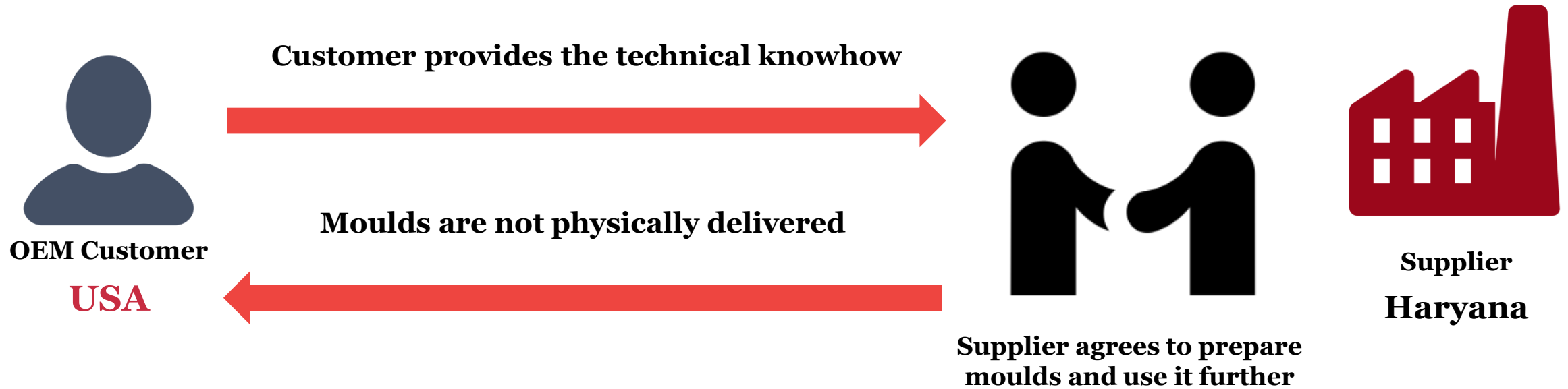

- Whether the above will qualify as export?
- Whether supply of moulds which is not physically delivered is intra-state or inter-state supply?
- Section 7(5)(c) - Inter-state Supply
- Can the supplier bill the moulds to customer in USA and ship to self so as to charge IGST in terms of 10(1)(b)?
- Will the above transaction be covered under Section 10(1)(c) since it does not involve movement of goods?

## Section 10 of IGST Act

*(1) The place of supply of goods, other than supply of goods imported into, or exported from India, shall be as under,—*

*(a) where the supply **involves movement of goods**, whether by the supplier or the recipient or by any other person, the place of supply of such goods shall be the location of the goods at the time at which the **movement of goods terminates for delivery to the recipient**;*

*(b) where the **goods are delivered by the supplier to a recipient or any other person on the direction of a third person**, whether acting as an agent or otherwise, before or during movement of goods, either by way of transfer of documents of title to the goods or otherwise, it shall be deemed that the said third person has received the goods and the place of supply of such goods shall be the **principal place of business of such person**;*

*(c) where the supply **does not involve movement of goods**, whether by the supplier or the recipient, the place of supply shall be the location of such goods **at the time of the delivery to the recipient**;*

## Section 7 of IGST Act

*(5) Supply of goods or services or both,—*

*(a) when the **supplier is located in India and the place of supply is outside India;***

*(b) to or by a Special Economic Zone developer or a Special Economic Zone unit; or*

*(c) **in the taxable territory, not being an intra-State supply and not covered elsewhere in this section,***

*shall be treated to be a supply of goods or services or both in the course of inter-State trade or commerce.*

# Case Study 4 - Bill to India and Ship to Outside India

- B filing Shipping Bill and mentioning A as manufacturer
- Ownership of goods from A to B will be transferred in India

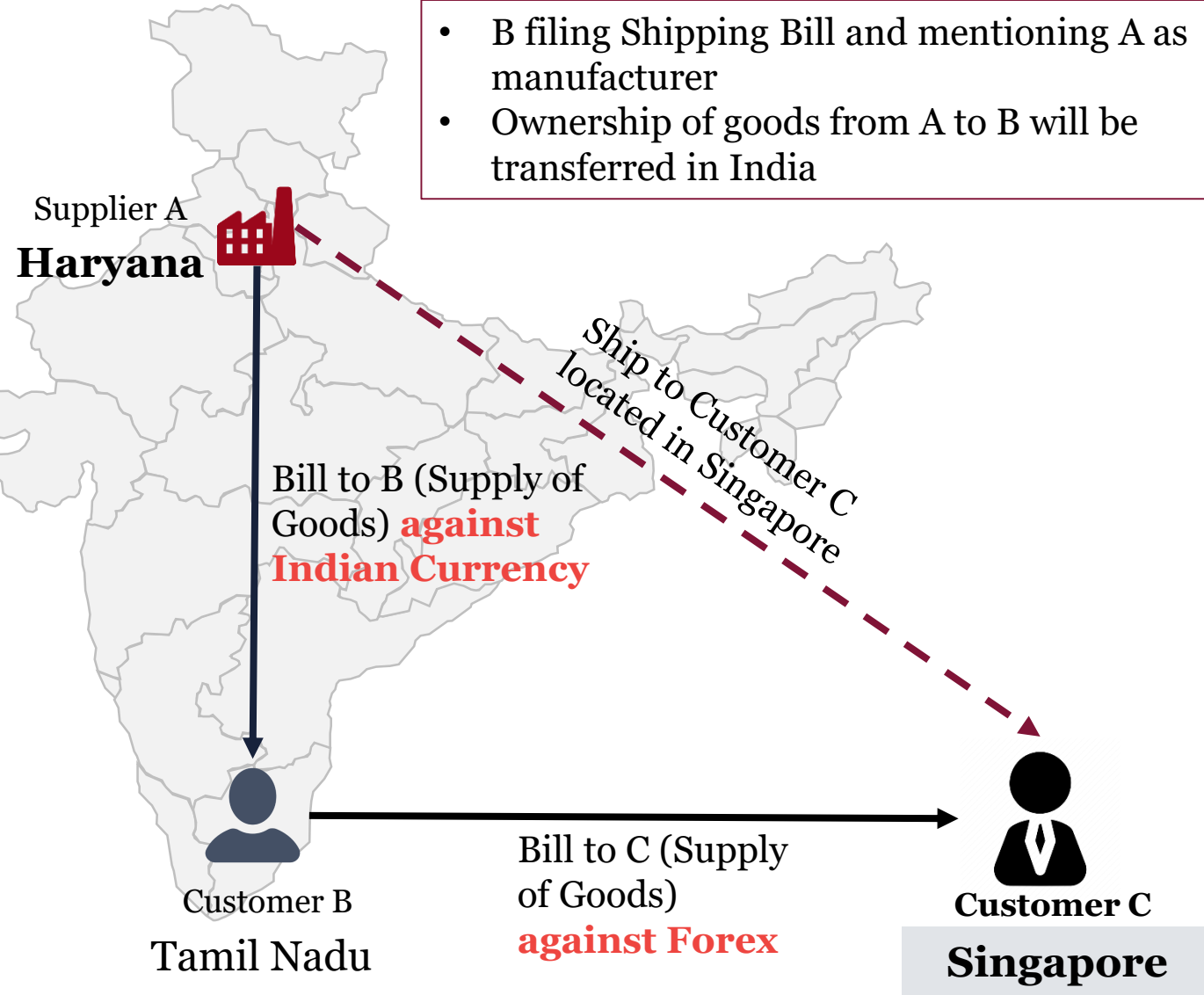

**Supply by A to B**

- Domestic transaction
- GST at the rate of 0.1% - NN 41/2017-IGST (R)

**Supply by B to C - Taxable under GST**

- Export of Goods
- ITC eligible

**Who can claim benefit**

- Drawback u/s S. 75 of the Custom Act
- MEIS
- Export Obligation for Advance Authorization

# Case Study 5: Bill to India and Ship to Outside India

- Supplier A filing Shipping Bill
- Ownership of goods from A to B will be transferred post custom frontiers of India

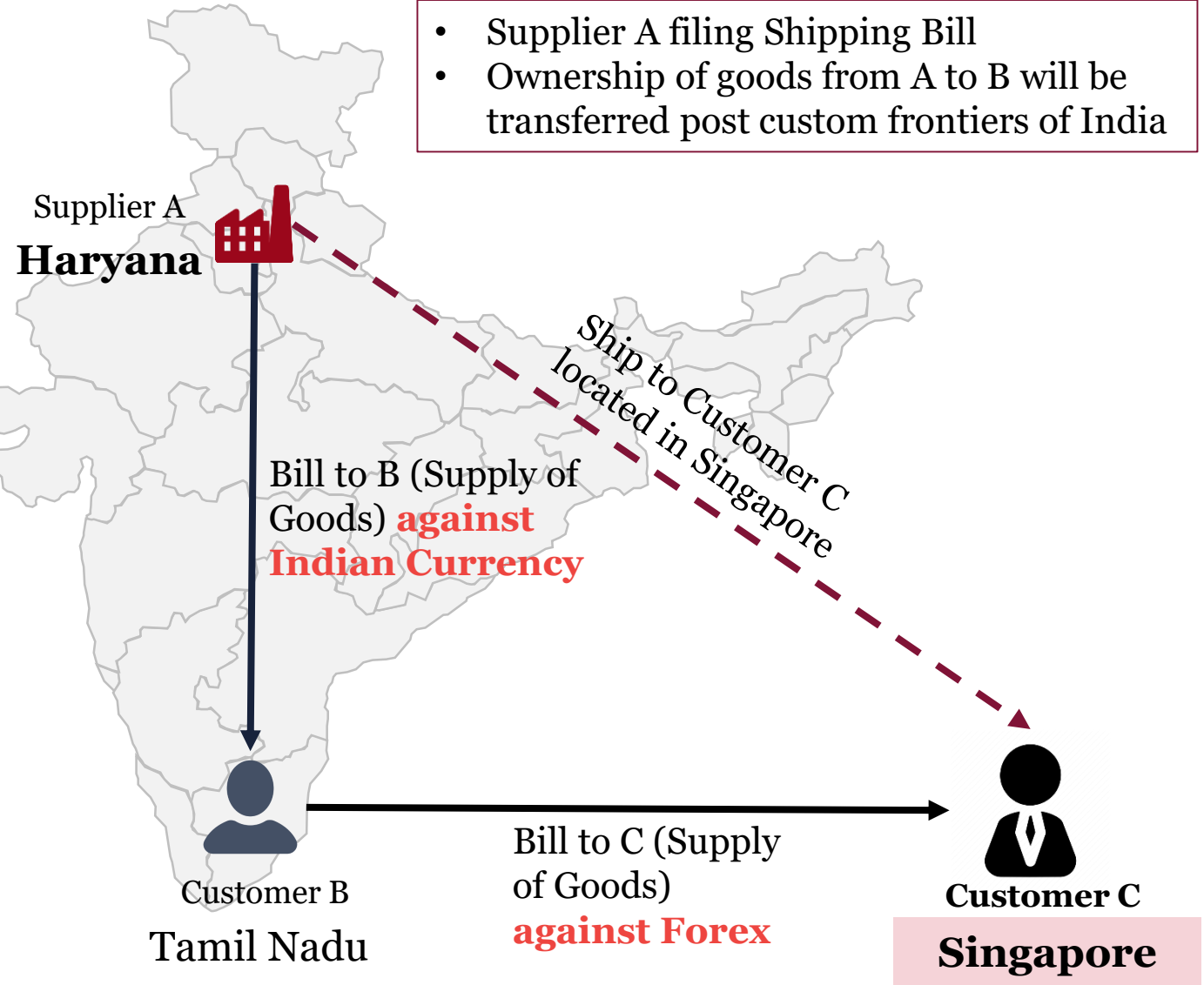

?

**Supply by A to B - Export under GST**

- Movement of goods outside India
- Rule 96B Compliance

**Supply by B to C - Taxable under GST**

- Supplies in non-taxable territory **or**
- Supplies in taxable territory as per S. 7(5)(c)
- No ITC

**Other Benefits to A**

- Drawback u/s S. 75 of the Custom Act
- MEIS
- Export Obligation for Advance Authorization

# Case Study 6 - Bill to Outside India and Ship to India

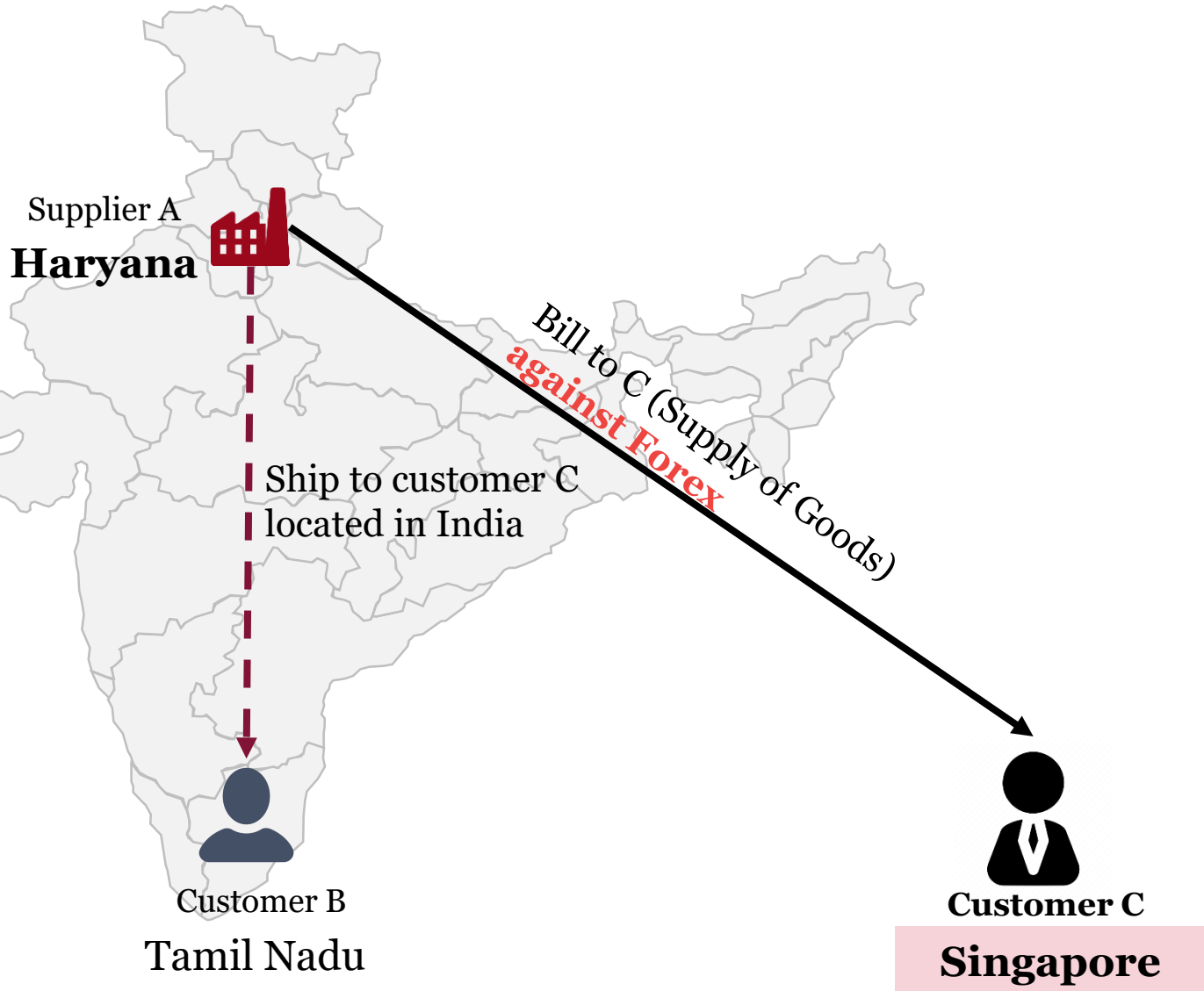

## Supply by A to C - Export under GST

- Movement of goods not outside India
- Place of Supply as per S. 10(1)(b) or
- Inter-state supply as per S. 7(5)(c)



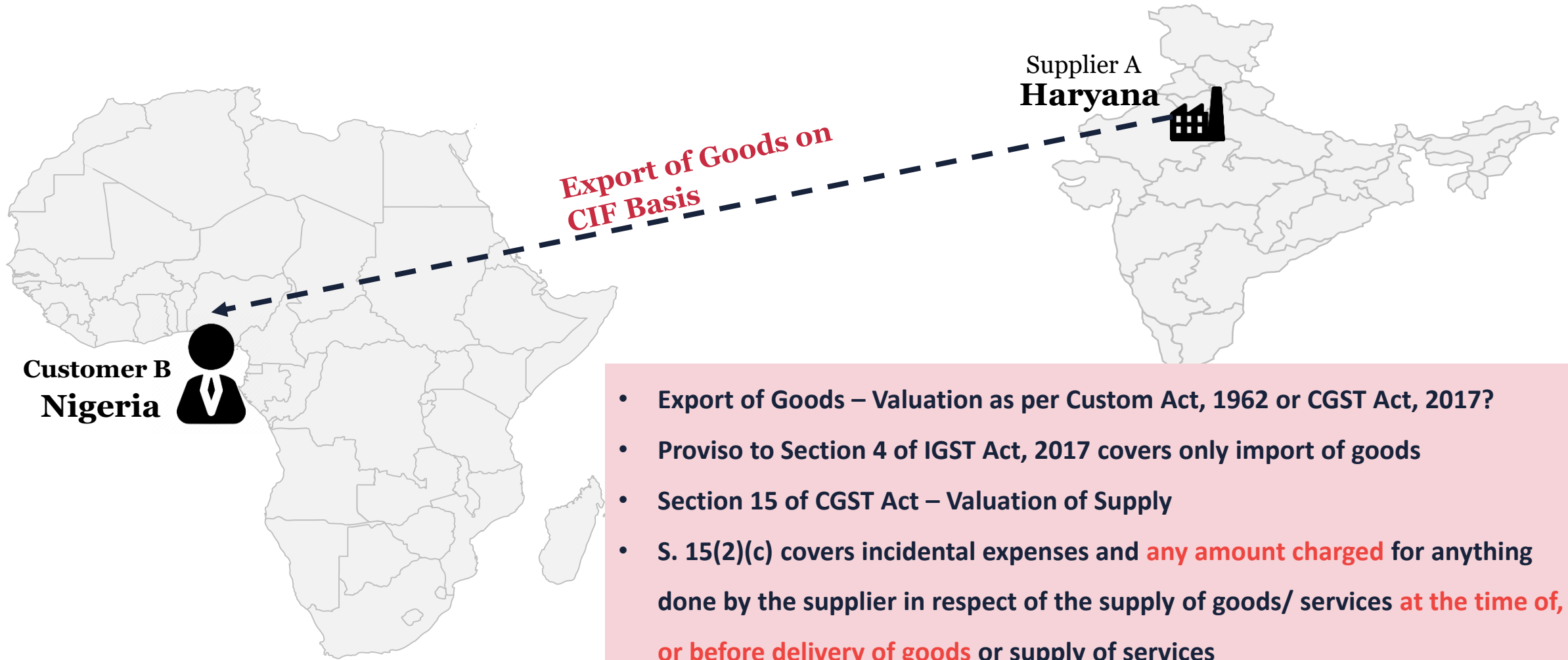

- Export of Goods – Valuation as per Custom Act, 1962 or CGST Act, 2017?
- Proviso to Section 4 of IGST Act, 2017 covers only import of goods
- Section 15 of CGST Act – Valuation of Supply
- S. 15(2)(c) covers incidental expenses and **any amount charged** for anything done by the supplier in respect of the supply of goods/ services **at the time of, or before delivery of goods** or supply of services
- India Meters Limited vs. State of Tamil Nadu (2010-VIL-11-SC)

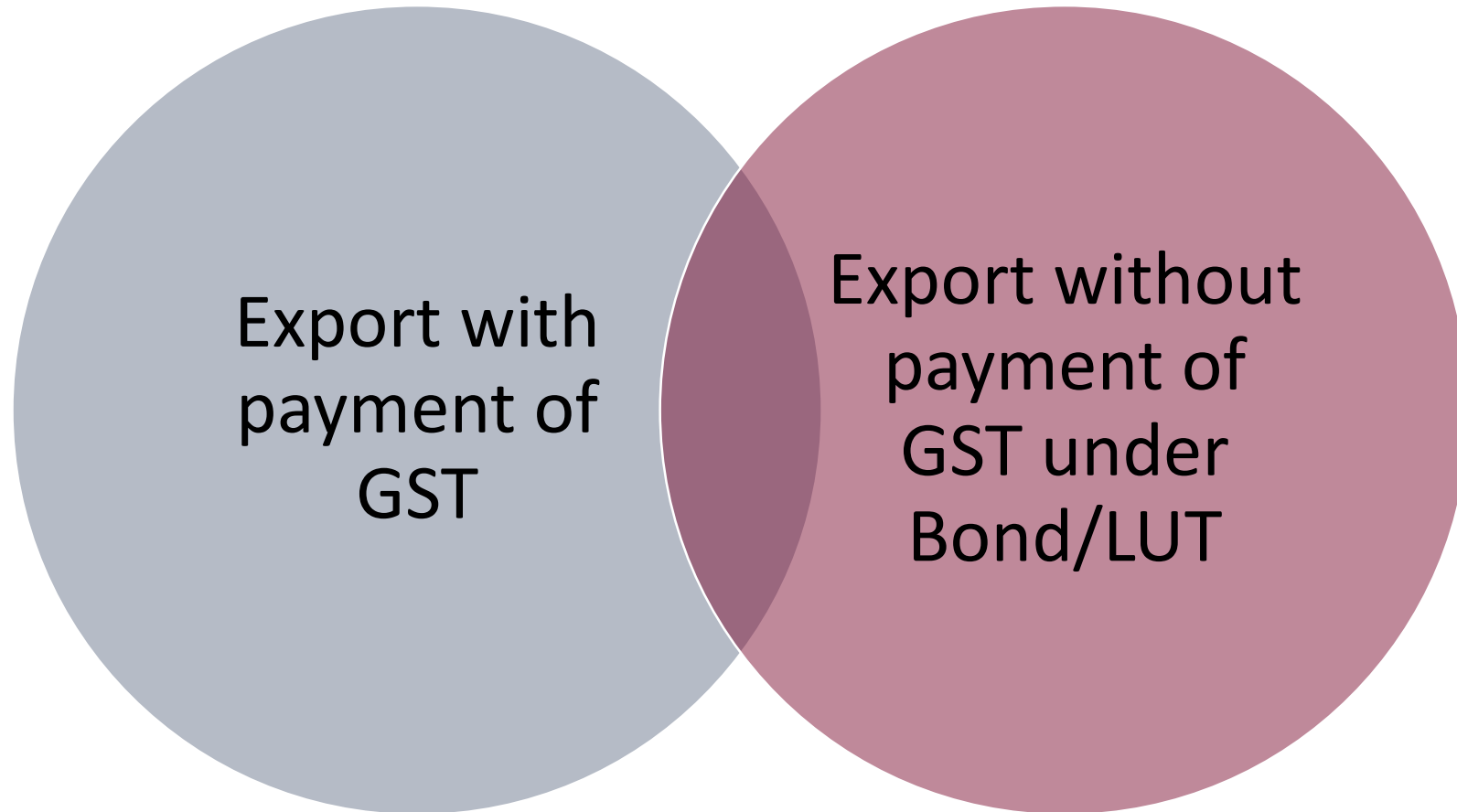



# Revision of Prices for Export

Export with  
payment of  
GST

Refund Claimed

Upward Revision in  
Prices

Downward Revision  
in Prices

- Section 15 - Valuation of Supply
- Section 34 - Debit Note - Payment of differential GST
- Section 50 - Interest on short payment of tax
- Refund on the basis of Debit Note
- Section 18 of Custom Act – Provisional Assessment
- Section 149 – Amendment of Shipping Bill
- Revenue Neutral – Short payment and short refund
- Commercial Debit Note

- **Excess Refund received – GST refund back**
- **Section 50: Interest on Excess Refund received**
- **Commercial Credit**

# Revision of Prices for Export

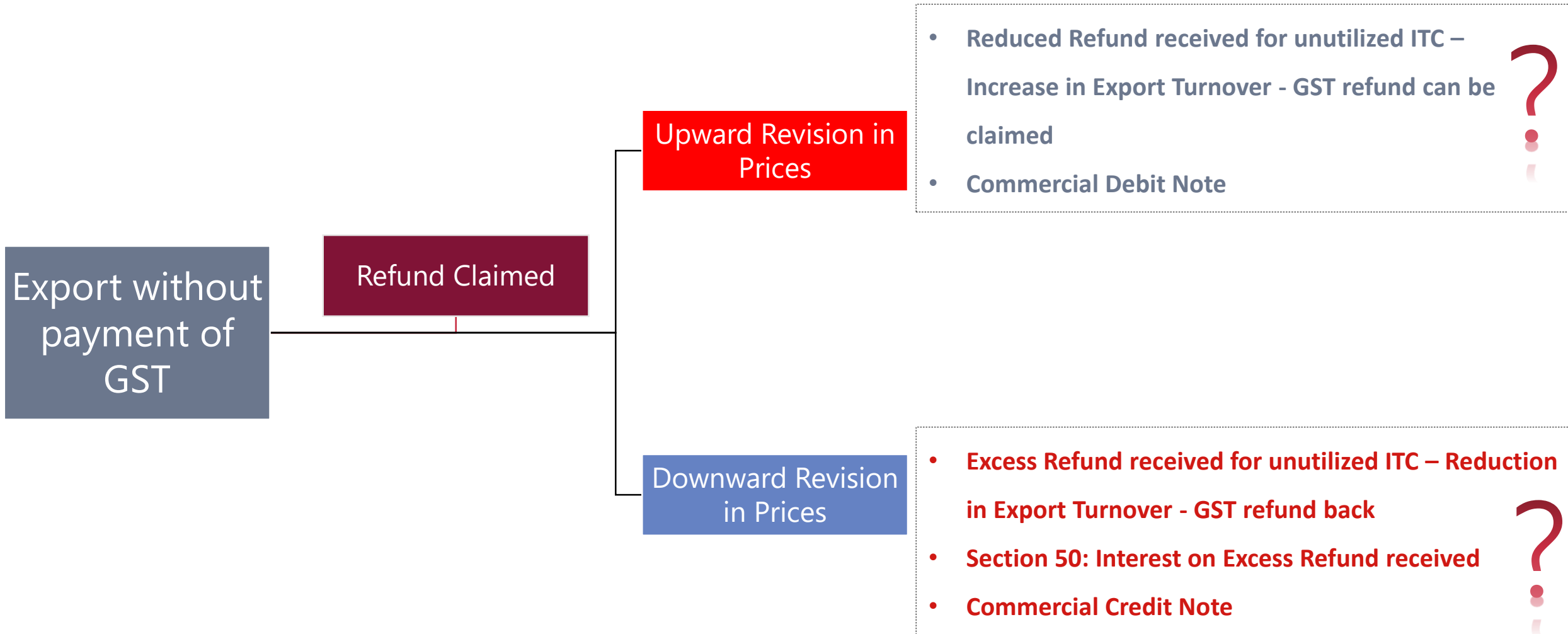

# Case Study 9: Schedule III Transactions

Inserted in Schedule III by CGST Amendment Act, 2017 w.e.f. **01.02.2019**

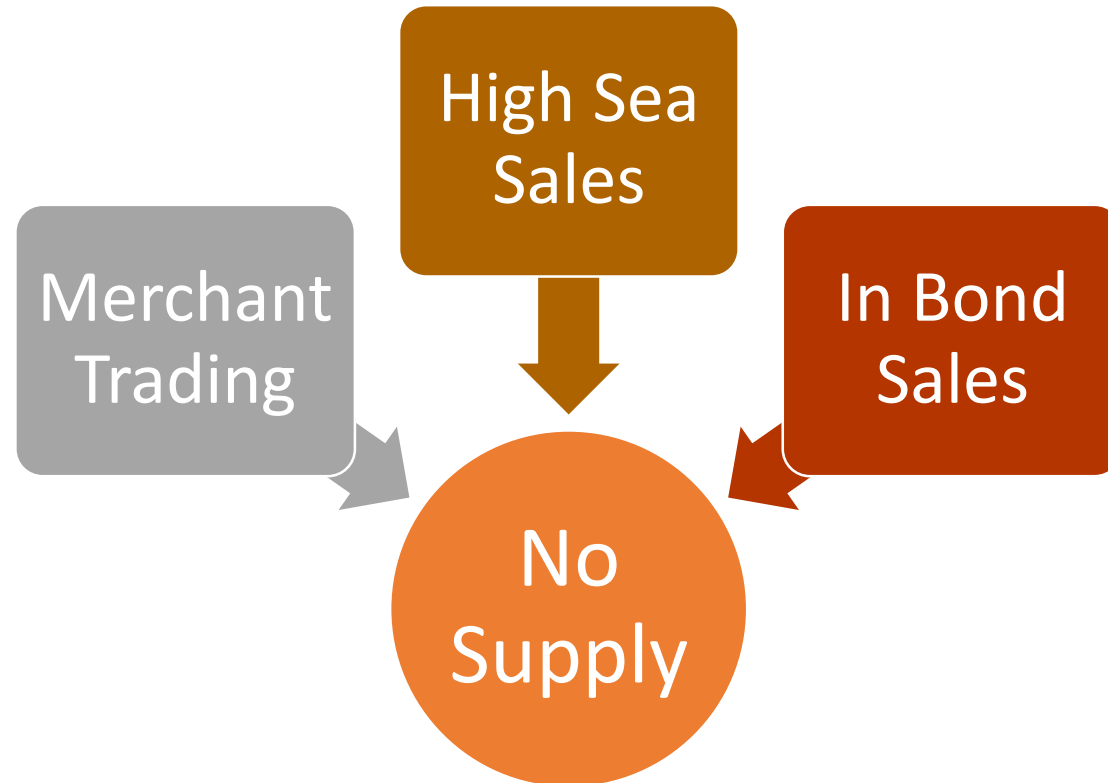

Before **01.02.2019**

- Proviso to Section 5: Import of Goods
- Import means bringing goods into India from a place outside India
- S. 2(11) of Custom Act: **customs area** means the area of a customs station 14[or a warehouse] and includes any area in which imported goods or export goods are ordinarily kept before clearance by Customs Authorities
- Circular No. 3/1/2018-IGST
- Circular No. 33/2017- Custom



8. (a) Supply of warehoused goods to any person before clearance for home consumption;  
(b) Supply of goods by the consignee to any other person, by endorsement of documents of title to the goods, after the goods have been dispatched from the port of origin located outside India but before clearance for home consumption.



**Court. Explanation 2.--For the purposes of paragraph 8, the expression “warehoused goods” shall have the same meaning as assigned to it in the Customs Act, 1962.**

- ❖ Supply of warehoused goods means when an importer files Bill of Entry for warehousing of goods and supply the goods from warehouse itself without clearing from home consumption.

*\* Sr. No (7) and (8) would imply that out and out supplies(i.e. merchant trading), sale of goods in custom bonded warehouse and High seas sales are treated as no supply under GST..*

# Circular No. 3/1/2018-IGST: In-bond sales

(on or after the 1st of April, 2018)

- *In case of supply of the warehoused goods, the point of levy will be the time of clearance of such goods as per Customs Act in terms of proviso to Section 5(1) of IGST Act.*
- *IGST shall be levied and collected at the time of final clearance of the warehoused goods for home consumption i.e. at the time of filing the ex-bond bill of entry*
- *Value will be either the transaction value or the valuation made at the time of filing the into-bond bill of entry, whichever is higher in terms of Section 3(8A) of CTA*
- *Section 3(8A)(a) of CTA provides that where the goods deposited in a warehouse under the provisions of the Customs Act are sold to any person before clearance for home consumption or export under the said Act, the value of such goods for the purpose of calculating the IGST under subsection (7) shall be the value determined under sub-section (8) or the transaction value of such goods, whichever is higher, where the whole of the goods are sold.*

- **Section 5 (1) of the IGST Act** inter alia provides that there shall be levied a tax called the integrated goods and services tax on all inter-State supplies of goods or services or both, on the value determined under section 15 of the Central Goods and Services Tax Act and at such rates, not exceeding forty per cent., as may be notified by the Government on the recommendations of the Council and collected in such manner as may be prescribed and shall be paid by the taxable person
- **Proviso to Section 5 (1) of the IGST Act** provides that the integrated tax on goods imported into India shall be levied and collected in accordance with the provisions of section 3 of the Customs Tariff Act, 1975 on the value as determined under the said Act at the point when duties of customs are levied on the said goods under section 12 of the Customs Act, 1962
- Further, **Section 7(2) of the IGST Act** provides that supply of goods imported into the territory of India **till** they cross the customs frontier of India shall be treated as a supply of goods in the course of inter-state trade or commerce.
- As per **2(10) of IGST Act**, "**import of goods**" with its grammatical variations and cognate expressions, means bringing goods into India from a place outside India
- Section 2(4) of the IGST Act defines '**Customs frontier of India**' as the limits of the customs area as defined in Section 2 of the Customs Act, 1962 (hereinafter referred to as the "Customs Act").
- As per Section 2(11) of the Customs Act, 'Customs frontier of India' is an area of a customs station **or a warehouse (inserted vide Taxation Amendment Act 2017)** and includes any area in which imported goods or export goods are ordinarily kept before clearance by Customs Authorities

# Merchant trading?



**INDIA**

**Instructs supplier in China to deliver to customer in USA**



**Goods are never brought into territory of India**



**Supplier  
China**



**Customer  
USA**

- Whether such supply is leviable to GST?
- Can 10(1)(a) & (c) apply in this case so as to attract levy of IGST?
- Can it be said that Sec. 10 is applicable for taxable territory?
- If yes, what is the place of supply?
- Contradictory Advance Rulings

## Batliboi & Company Pvt. Ltd. v. The State of Maharashtra (1981 47 STC 321 Bom HC)

### Facts:

- The applicants had entered into a contract with an Indian customer to sell certain equipment manufactured in Czechoslovakia. The terms of the agreement prescribed that the property in the machine shall stand transferred to the customer as soon as the machine is packed in crates for shipment from Czechoslovakia.
- The applicants inter alia contended that as the sale in the instant case occurred outside India, the same would not attract levy of tax under the Bombay Sales Tax Act, 1959 as the sale did not take place ‘inside the state’ as per the parameters prescribed under Section 4 (2) of the Central Sales Tax Act, 1956 (“CST Act”) which provide for when a sale or purchase of goods shall be deemed to take place within a state.

### Judgment:

- The Bombay High Court held that from a combined reading of Section 4 (1) and 4 (2) of the CST Act, it is clear that Section 4 only deals with sales and purchases within India and it lays down the principles for determining when a sale or purchase can be said to be in any given State in the country itself.
- A sale which is inside one State is deemed to be outside all other States. **Accordingly, Section 4 has no application to sales or purchases which have taken place outside the country altogether. Sales which are not in any State in India but are outside the country altogether are not governed by section 4 of the CST Act.**
- Accordingly, based on the above reasoning, the court held that the applicant cannot take recourse to Section 4(2) of the CST Act in order to state that the sale was not taxable under the Bombay Sales Tax Act, 1959



## Section 17 of CGST Act

*(2) Where the goods or services or both are **used by the registered person partly for effecting taxable supplies** including zero-rated supplies under this Act or under the Integrated Goods and Services Tax Act and **partly for effecting exempt supplies under the said Acts**, the amount of credit shall be restricted to so much of the input tax as is attributable to the said taxable supplies including zero-rated supplies.*

*(3) The value of exempt supply under sub-section (2) shall be such as may be prescribed, and **shall include** supplies on which the recipient is liable to pay tax on reverse charge basis, transactions in securities, **sale of land and, subject to clause (b) of paragraph 5 of Schedule II, sale of building.***

# Input Tax Credit Reversal

**After 01.02.2019**

**Explanation inserted in Section 17(3) w.e.f. 01.02.2019**

*Explanation.-For the purposes of this sub-section, the expression “value of exempt supply” shall not include the value of activities or transactions specified in Schedule III, except those specified in paragraph 5 of the said Schedule.*

**Before 01.02.2019**

(47) **“exempt supply”** means supply of any goods or services or both which attracts nil rate of tax or which may be wholly exempt from tax under section 11, or under section 6 of the Integrated Goods and Services Tax Act, **and includes non-taxable supply**

(78) **“non-taxable supply”** means a supply of goods or services or both which is not leviable to tax under this Act or under the Integrated Goods and Services Tax Act;

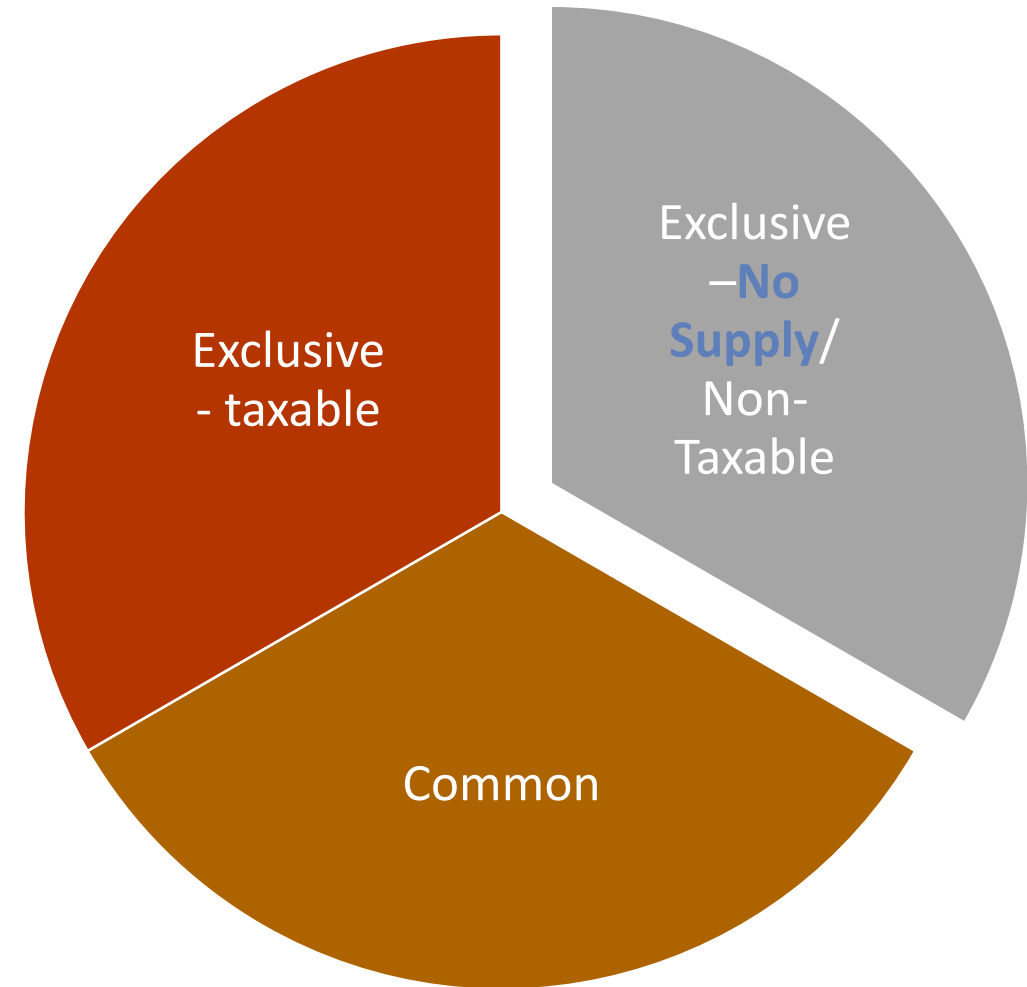

# Case Study 10 : Can goods sold to tourist by duty free shops be treated as export?

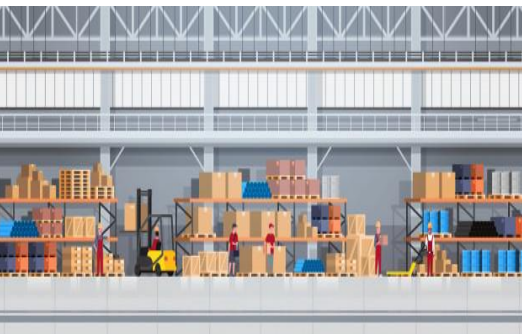

Imported goods from  
warehouse



Goods Procured  
Domestically



Duty Free Shop  
at International  
Departure

Supply of perishable goods

Supply of non perishable  
goods



Tourist who shall  
take goods outside  
India

*Treatment of goods directly brought in from warehouse?*

*Shall the goods supplied to tourist be treated as export?*

It was held that sale of eatables or goods to foreign going aircraft for consumption on board will not qualify as sale in the course of export, within the meaning of section 5(1) of the Central Sales Tax Act, 1956

### **Relevant Paras:**

*77. To establish an export, a person exporting and a person importing are necessary elements. As observed hereinabove, in the case at hand, no person exporting and person importing are to be found. What we get is a person selling, namely, the petitioners and the person purchasing the goods, namely, the foreign airlines. The purchase of goods is not for export but for consumption on board an aircraft during the period the aircraft is a foreign going aircraft.*

...

*87. From the above, it is clear though petitioners claim that the sales made by them were effected in the course of exports there was no place of destination outside India to treat the sales effected by the petitioners as sales in the course of export. The sales were effected to the customer who is a foreign airline for consumption on board an aircraft during the course of foreign going journey which may have incidentally taken the goods beyond the territory of India for consumption of their foreign going passengers, that by itself could not be considered that the sales were effected in the course of exports. When a place of destination outside India is absent, mere transportation of goods beyond the Indian Territory does not amount to sale in the course of export.*

Section 5(1) of CST Act, 1956 states, a sale or purchase of goods shall be deemed to take place in the course of the export of the goods out of the territory of India only if the sale or purchase either occasions such export or is effected by a transfer of documents of title to the goods after the goods have crossed the customs frontiers of India.

The duty-free shops being within the customs frontiers, the sale to customers from such duty-free shops was held to be in the course of export and thus exempt from the levy of sales tax in terms of Section 5(1) of the CST Act.

This position was also supported by the judgement of Hon'ble Supreme Court in case of ***Hotel Ashoka v Assistant Commissioner of Commercial Taxes***. The apex Court in the said decision took note of the fact that Duty Free Shops are located in a Zone which is entered by crossing the customs frontier of India, i.e. they are not within the customs frontiers of India and any sales from the said area is duly covered under Section 5(1) of the CST Act

***However, in absence of specific provisions under GST law the ratio decided by above case cannot be applied in GST regime.***

The decision of the Hon'ble Supreme Court in Hotel Ashoka does not appear to be applicable in the present case as in the said case, the Hon'ble Supreme Court had interpreted the scope of Section 2(11) of the Customs Act, 1962 under which "Customs area" were defined. No doubt, the duty free shops may be established beyond the Customs Frontiers of India. However, the issue in the present case is whether the said duty free shops are outside India i.e. whether they are "beyond airspace on territorial waters of India".

In the present case, as per Section 2(5) of the IGST Act 2017, export of goods takes place only when goods are taken out to a place outside India. Further, India is defined under Section 2(27) of the Customs Act, 1962 as "India includes the territorial waters of India". Similarly, under CGST Act 2017, under Section 2(56), India means the territory of India including its territorial waters and the air space above its territory and territorial waters. Hence, the goods can be said to be exported only when they cross the territorial waters of India and the goods cannot be called to be exported, merely on crossing the Customs Frontiers of India

It is observed that "export of goods" has been defined under Section 2(5) of the IGST Act, 2017 as taking goods out of India to a place outside India. The India is defined under Section 2(56) of the CGST Act as "India" means the territory of India as referred to in article 1 of the Constitution, its territorial waters, seabed and sub-soil underlying such waters, continental shelf, exclusive economic zone or any other maritime zone as referred to in the Territorial Waters, Continental Shelf, Exclusive Economic Zone and other Maritime Zones Act, 1976, and the air space above its territory and territorial waters". Hence, when goods are exported by Air, ***the export will be completed only when goods crosses airspace limits of its territory or territorial waters of India.***



# CASE STUDIES – SERVICE



Tattvam Advisors Copyright

## *Mohit Minerals Pvt. Ltd. by Gujarat High Court*

- It was held that no IGST is leviable on the ocean freight for the services provided by a person located in a non-taxable territory by way of transportation of goods by a vessel from a place outside India upto the customs station of clearance in India.
- Notification No. 8/2017 (I.T.R.) and Entry 10 of Notification No. 10/2017 (I.T.R.) declared as ultra vires the IGST Act due to lack of legislative competency and accordingly held to be unconstitutional.

## **Observations by Gujarat High Court**

- Under Section 5(3) of the IGST Act, the person liable to pay tax can only be “the recipient” of supply. Importer cannot be said to be the recipient of the ocean freight service in the instant case since the importer has neither availed the service of transportation of goods nor he is liable to pay consideration for such service.
- It is neither an inter-state supply under Section 7 nor an intra-state supply under Section 8 of the IGST Act
- The freight has already suffered the IGST as a part of value of goods imported. Dual levy of the IGST cannot be imposed treating it as supply of service. Double taxation, through delegated legislation, where the statute does not provide, is not permissible.



# SECTION 7(5)(C) AND PLACE OF SUPPLY – MOHIT MINERALS VS UOI, GUJARAT HC

- Supply in taxable territory different from place of supply in India.
- Does not cover all supplies where POS lies in India
- Place of supply provisions only to be used where provided under the Act and therefore cant be used with Section 7(5)(c)
- Deeming Fiction and can cover the transaction of tax evasion where supply identified but not possible to determine whether it is intra-state or inter-state.
- Majority of the aspects of the transaction should take place in India.
- Foreign tour operator conducting tour in India for foreign tourist?**

*Section 7(5)(c): Supply of goods or services in a taxable territory, not being an intra-state supply and not covered elsewhere shall be treated to be supply of goods or services in the course of inter-state trade or commerce.*

**Supply in taxable  
territory**

# Case Study 12 – RCM on ECB charges paid to foreign bank

The place of supply of the following services shall be the location of the supplier of services, namely:

(a) Services supplied by a Banking company, or a financial institution, or a banking financial company to account holders;

(b) Intermediary services

(c) Services consisting of hiring of means of transport, including yachts but excluding aircrafts and vessels, up to a period of one month

Explanation- For the purposes of this sub- section, the expression,-

(a) "account" means an account bearing interest to the depositor, and includes a non-resident external account and a non-resident ordinary account;

(b) "banking company" shall have the same meaning as assigned to it under clause (a) of section 45A of the Reserve Bank of India Act, 1934;

(c) "financial institution" shall have the same meaning as assigned to it in clause (c) of section 45-I of the Reserve Bank of India Act, 1934;

(d)

“non-banking financial company” means,—

- a financial institution which is a company;
- a non-banking institution which is a company and which has as its principal business the receiving of deposits, under any scheme or arrangement or in any other manner, or lending in any manner; or
- such other non-banking institution or class of such institutions, as the Reserve Bank of India may, with the previous approval of the Central Government and by notification in the Official Gazette, specify.

# Intermediary Services

- Section 13(8)(b):POS= Location of supplier of services.
- *Definition of Intermediary [Section 2(13)]*
  - *"intermediary" means a broker, an agent or any other person, by whatever name called, who arranges or facilitates the supply of goods or services or both, or securities, between two or more persons, but does **not include** a person who supplies such goods or services or both or securities **on his own account**;*

- CSC Financial Services Ltd vs Commissioner of Excise and Custom [C-235/00]
- Arthur Anderson & Co. Accountants vs Staatssecretaris van Financien [C-473/03]
- M/s Book it Ltd. vs Customs and Excise [(2004) UK V18626 (28 May 2004)]
- Five Star Shipping [2018-VIL-21-AAAR]
- Sunrise Immigration Consultants Private Limited vs CCE & ST, Chandigarh [2018-VIL-539-CESTAT-CHD-ST]
- Toshniwal Brothers (Sr) Pvt Ltd [2018-VIL-203-AAR]
- GoDaddy India Web Services (P) Ltd [2016-VIL-08-ARA]

## ***A. UK VAT Notice 701/49***

Supplier providing intermediary services is a person who -

- Brings together a person seeking financial service with a person who provides financial services
- Stands between the parties to the contract and act in an intermediary capacity; and
- Undertakes work preparatory to the completion of the contract for provision of financial services, whether or not it is completed

## ***B. Commissioners of Customs & Excise v CSC Financial Services Ltd (“CSC” – Case C-235/00 – [2002] STC 57)***

Where one of the parties entrusts to a sub contractor some of the clerical formalities related to the contract, such as providing information to the other party and receiving and processing applications, the subcontractor occupies the same position as the party selling the financial product and is not therefore an intermediary.

## ***C. Andersen/Accenture case (C-472/03)***

The European Court of Justice held that essential aspects of the work of an insurance agent includes finding of prospects and their introductions to the insurer. Where the services provided in relation to insurance does not have the above elements, the supplier shall not be considered to be insurance agent.

## ***D. Leadx Vs. Revenue & Customs***

Mere introduction of buyer with the seller is not sufficient for a service provider to qualify to be an intermediary. Activity of gathering information / sorting the same does not necessarily mean that it is an act of facilitating provision of the main service.

## ***E. Sabre Travels Network India Pvt Ltd [2018-VIL-314-AAR]***

Maharashtra AAR has held that the marketing, promotion and distribution services provided by applicant to its parent company, situated in Singapore in lieu of a fixed consideration based on cost plus markup will be considered as intermediary services as applicant is providing such services on account of group company and not on his own account

## ***F. Sunrise Immigration Consultants Pvt Ltd. vs CCE & ST, Chandigarh [2018-VIL-539-CESTAT-CHD-ST]***

Applicant was providing visa facilitation and referral services to foreign universities and he contended that services provided by him has no concern with education imparted by universities. The Chandigarh Tribunal observed that the appellant is nowhere providing services between two or more persons. The nature of service provided by the appellant is the promotion of business of their client, in terms, he gets commission which is covered under business auxiliary service which is not the main service provided by the main service providers namely banks/university

## ***G. M/s Evalueserve.com Pvt Ltd v CST Gurgaon [2018 (3) TMI 1430 – CESTAT CHANDIGARH]***

Applicant was engaged in business/market research and intellectual property related activities for client outside India. Tribunal held that services provided by client does not have direct nexus with customers of client. Further, services have been provided on principal to principal basis. Therefore, it shall not qualify as intermediary.

## ***H. Toshniwal Brothers (Sr.) Pvt Ltd. [2018-VIL-203-AAR]***

Applicant was providing marketing, sales promotion and certain post sales support services to foreign client. No consideration was payable without supply being made by foreign client. Karnataka AAR treated these services as intermediary.

## ***I. Global Reach Education Services Pvt Ltd [2018-VIL-4-AAAR]***

Consideration dependent upon number of students referred by applicant. West Bengal AAAR termed the applicant as intermediary

## ***J. Five Star Shipping [2018-VIL-21-AAAR]***

Maharashtra AAAR held that the Appellant has framed the agreement in such a manner so that their activity as intermediary is not revealed at any stage by projecting themselves as mere consultant to the Foreign Ship Owners, with an intent to avoid the levy of GST on the services provided to the FSO - the Appellant is actually facilitating the supply of the main services i.e. chartering of the vessels by the FSO to their clients, thereby clearly acting as an intermediary, as the chartering of the vessels is not the main service of the Appellant. Appellant are performing all these services on behalf of their principal i.e. the FSO, thus acting as an intermediary.

## ***K. GoDaddy India Web Services Pvt Ltd [2016-VIL-08-ARA]***

It was stated that persons such as call centres, who provide services to their clients by dealing with the customers of the client on client's behalf, are actually providing these services on their own account, will not be categorized as intermediaries. Thus, pure marketing and promotion activities are not termed as intermediary services.

## ***L. Vservglobal Private Limited [2018-VIL-270-AAR]***

Issue related to classification of back-office support services and accounting services provided by Applicant to overseas clients. The Authority pointed out that the activities performed by the applicant for the clients indicates the Applicant to be a person who arranges or facilitates the supply of goods or services or both between the clients and customers of the clients, and therefore, held that the applicant is clearly covered under the definition of an intermediary under GST





## *Investment Advisory Services vs. Intermediary Services*

- Company A located in India advising to Fund located in Singapore about potential investment opportunities in India.
- Subject to acceptance of advise by fund, Company A starts studying the target company in detail and also participate in negotiation with target company.
- **The ultimate objective is investing in India which can be through shares/ debentures/ etc.**

## *Intermediary Services*

Section 2(13) -“intermediary” means a broker, an agent or any other person, by whatever name called, *who arranges or facilitates the supply of goods or services or both, or securities*, between two or more persons, but does not include a person who supplies such goods or services or both or securities on his own account

# Case Study 14 - Promotion of foreign university?

## OUTSIDE INDIA



XYZ University

Commission received in FX



## INDIA

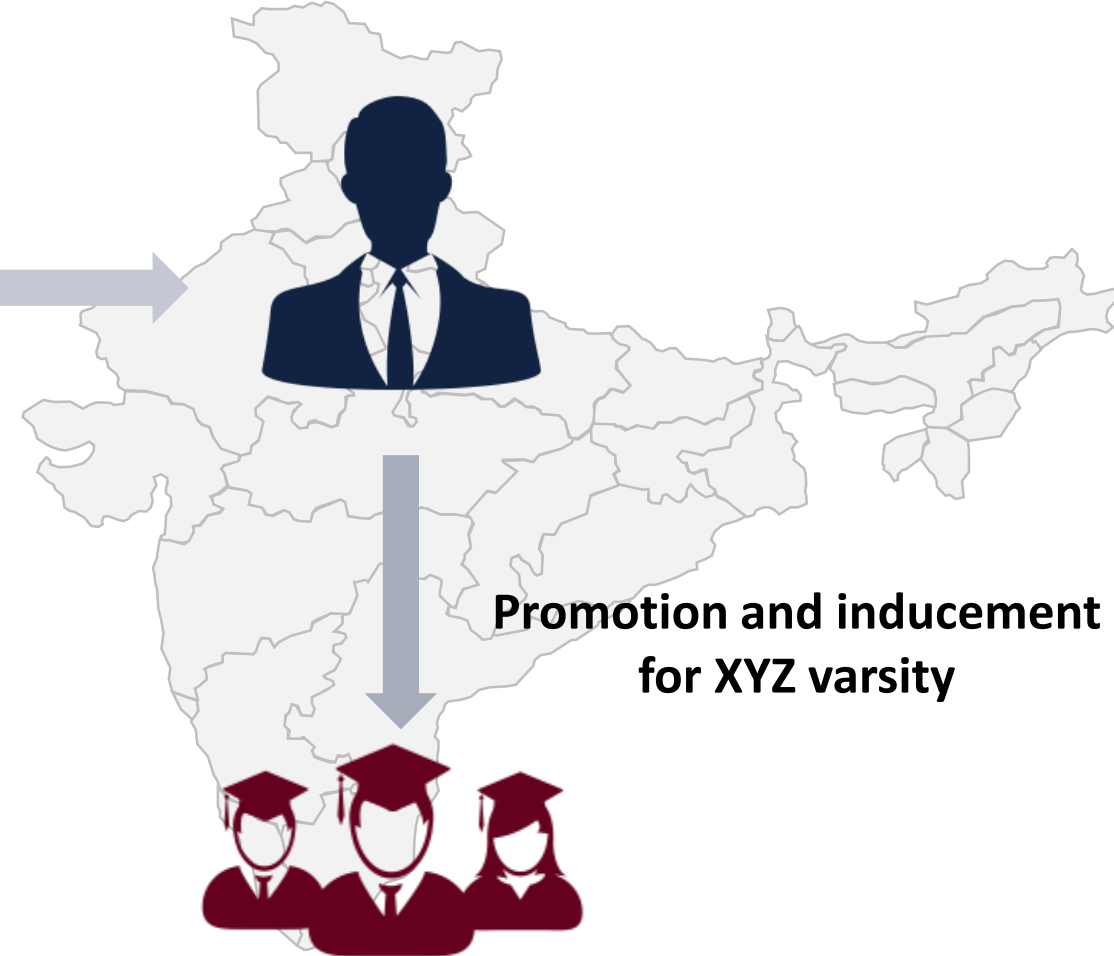

### ISSUES:

Whether promotion is principal supply or facilitating recruitment of students?

As per AAR (Global reach), intermediary.

## Summary

### Place of Supply directly in relation to Immovable Property

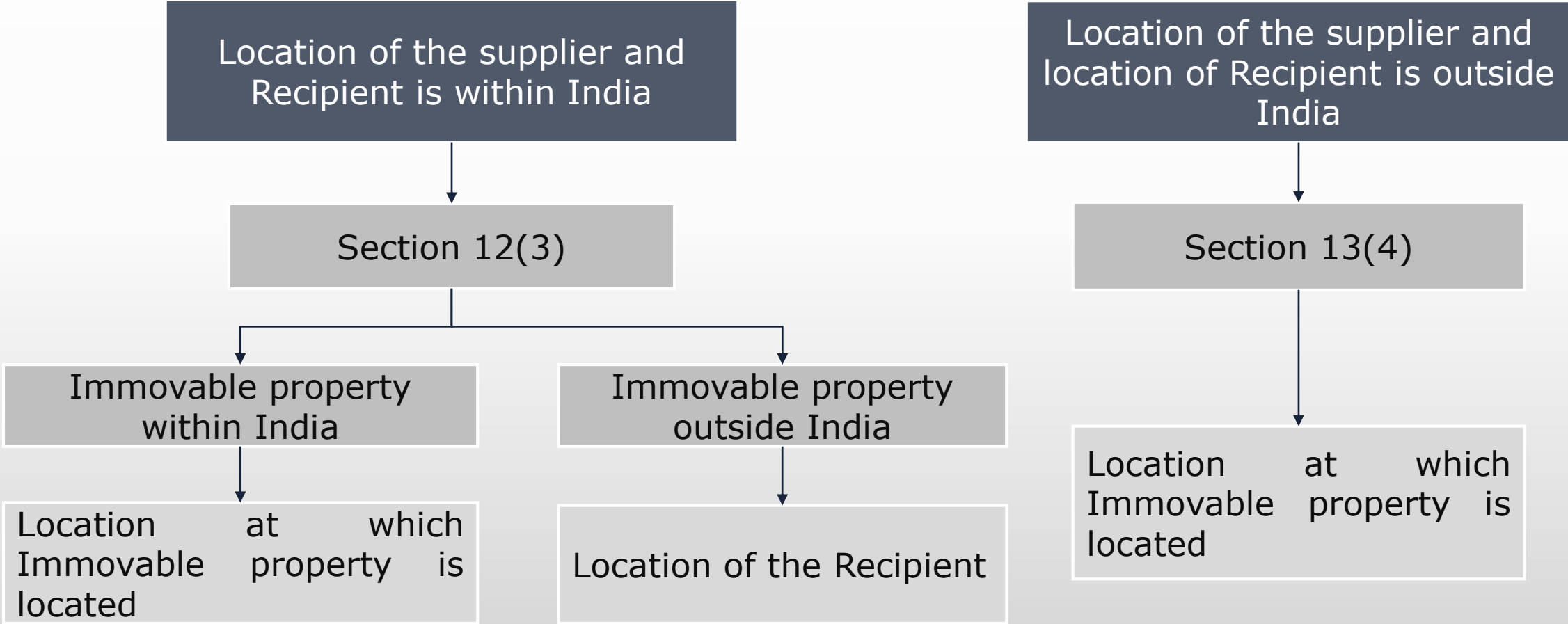

## Australia GST Ruling 2003/7

Factors for determining whether services are directly related with immovable property

- Change in physical characteristics
- Physical interaction with property without changing its characteristics
- Establishes value of property
- Affects or protects nature/value of property
- Affects ownership including interest/rights in property

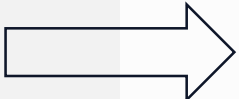

**Construction, repair and maintenance**

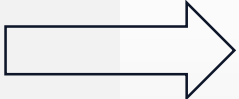

**Security Services**



**Surveying Services**

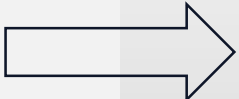

**Insurance, management services**

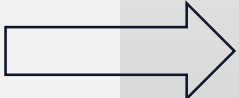

**Conveyancing Services**

## Europe

*Article 47 of the European VAT Legislation: Supply of services connected with immovable property’.*

***Explanatory Notes:***

*Include only those services that have a **sufficiently direct connection with that property:***

- a) Where they are **derived from an immovable property** and that property makes up a constituent element of the service and is central to, and **essential for, the services supplied;***
- b) Where they are provided to, or directed towards, an immovable property, having as their object the **legal or physical alteration of that property.***



## New Zealand

### *‘Services directly in connection with land’*

- *Where there is a sufficient relationship between two things, so as to be ‘in connection with’ each other, is a **matter of fact and degree and impression** which requires a **common-sense assessment of the factual position**.*
- *A **close connection would be required** between a service and land for the service to be regarded as a service that is supplied ‘directly in connection with’ the land;*
- *Services that merely bring about or facilitate a transaction that has **direct effect on land and which are one step removed from a transaction** that has a direct effect on the land are not supplied ‘directly in connection with’ the land. This though is a matter of fact and degree.*

## Australia

### *‘Services directly connected with goods or real property’*

- *A very **close link or association** between the supply and goods or real property.*
- *For example, a supply of advice or information to a non-resident about the potential for investment in the real property market in Melbourne is not directly connected with real property. While the supply is connected with real property, the **generality of the advice or information means that the supply does not have a direct connection with real property**. The supply is not one so closely connected with real property in Melbourne that the place of consumption is regarded as Melbourne.cc*

# Case Study 16 – Foreign Currency Saved is Foreign Currency earned

CIT vs Henna Zebraat  
J.B.Boda & Co (P) Ltd vs CBDT



In these decisions, the courts have held that while the law requires bringing into India the export proceeds and if the assessee has to make a payment outside India then it serves no purpose to first bring the export proceeds to India and then remit the same outside India for incurring expenses and that such a two-way channel of money flow is unnecessary



National Engineering Industries  
Limited – Delhi Tribunal

The assessee was booking business for foreign supplier for export of goods to Indian Railways and payment in foreign exchange was made to foreign supplier by the Indian Railways. The Indian Railways, instead of making payment of foreign exchange to the foreign supplier paid to the assessee in rupee equivalent of foreign exchange and deducted that amount from payment to foreign supplier. The department contended that since the consideration was received in rupee and not foreign exchange the condition of export was not fulfilled. The Hon'ble Tribunal held that foreign exchange which otherwise would have flown out of India, due to import by Indian Railways, was saved by the above arrangement. Thus, the object of export of service was fulfilled.

**Both Supplier and Recipient in India : (No specific Provision)**

- Registered Recipient    ➡    Location of Recipient
- Unregistered Recipient    ➡    Address on Record



Inspection/Testing

**Either Supplier or Recipient abroad : [Section 13(3)(a)]**

Place of supply of services supplied **in respect of goods** which are required to be made physically available to the supplier of services in order to provide the services, shall be the location where services are performed



When are services said to be in respect of Goods ???



The place of supply of the following services shall be the location where the services are actually performed, namely:—

- (a) services supplied in respect of goods which are required to be made physically available by the recipient of services to the supplier of services, or to a person acting on behalf of the supplier of services in order to provide the services

Provided that when such services are provided from a remote location by way of electronic means, the place of supply shall be the location where goods are situated at the time of supply of services

**Before 01.02.2019**

*Provided further that nothing contained in this clause shall apply in the case of services supplied in respect of goods which are temporarily imported into India for repairs and are exported after repairs without being put to any other use in India, than that which is required for such*

**Inserted by CGST Amendment Act w.e.f. 01.02.2019**

*Provided further that nothing contained in this clause shall apply in the case of services supplied in respect of goods which are temporarily imported into India for repairs or for any other treatment or process and are exported after such repairs or treatment or process without being put to any use in India, other than that which is required for such repairs or treatment or process.*

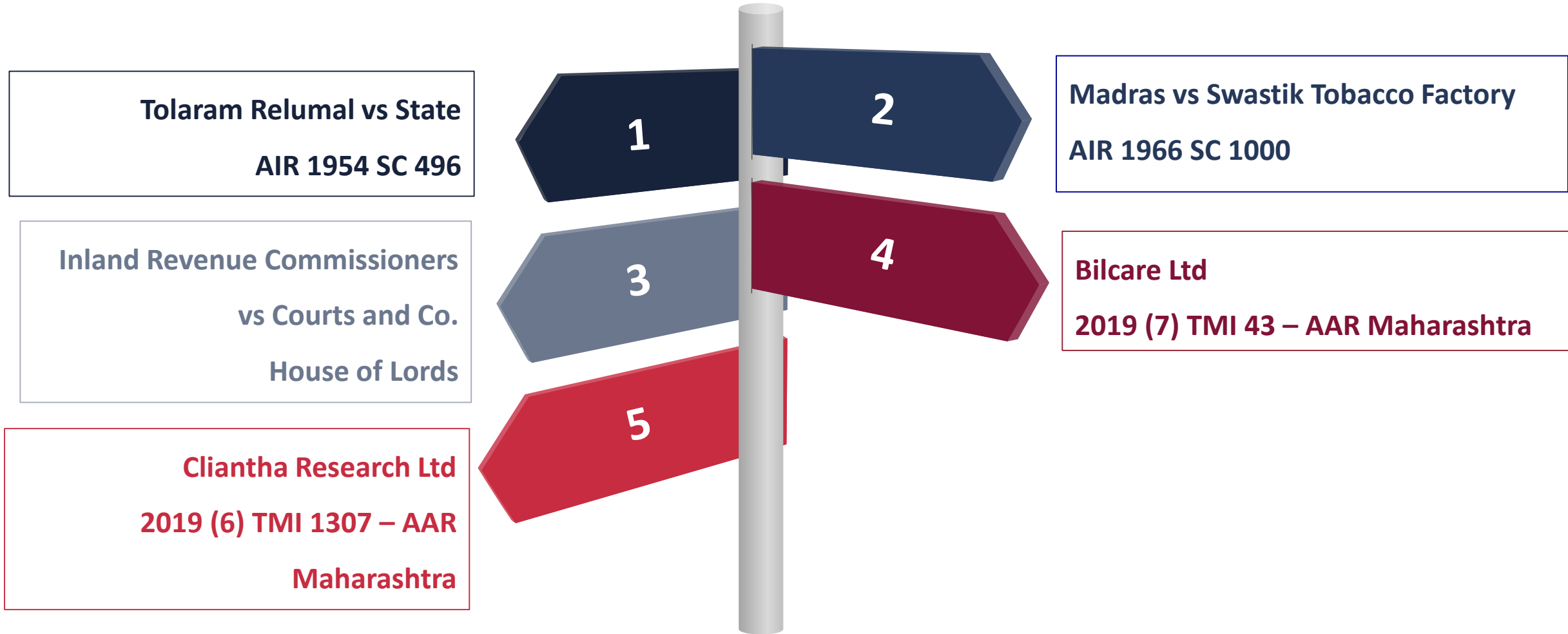

**Tolaram Relumal vs State**  
AIR 1954 SC 496

**Madras vs Swastik Tobacco Factory**  
AIR 1966 SC 1000

**Inland Revenue Commissioners  
vs Courts and Co.**  
House of Lords

**Bilcare Ltd**  
2019 (7) TMI 43 – AAR Maharashtra

**Clantha Research Ltd**  
2019 (6) TMI 1307 – AAR  
Maharashtra

# Case Study 18: Export of service to Nepal?

NEPAL/BHUTAN



Customer

Leviable to NIL rate if received in

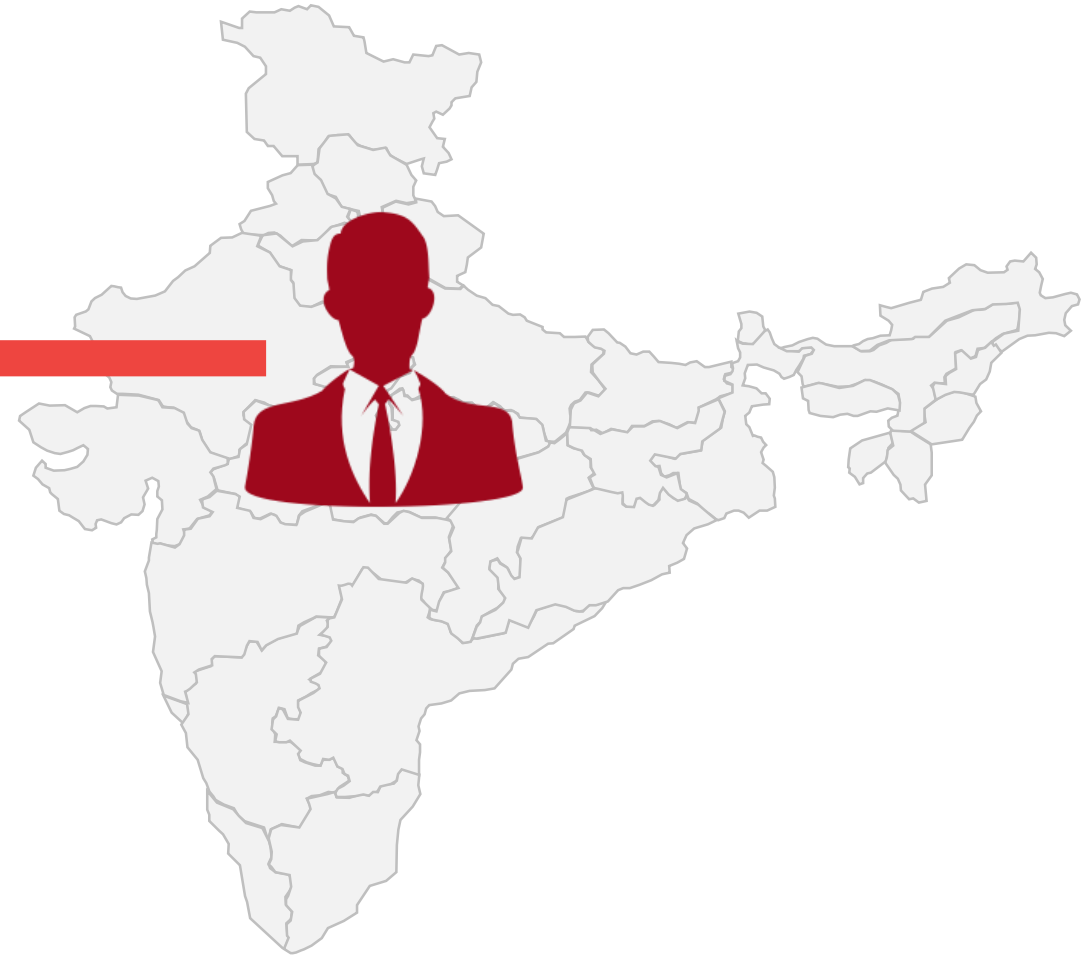

**w.e.f. 01.02.2019**

Export of Services: Payment can be received in Indian rupees wherever permitted by the Reserve Bank of India

**After 01.02.2019:**

- Whether export of services?

**Before 01.02.2019:**

- Whether exempt supply?
- Whether proportionate ITC to be reversed?

## **A. Refund eligible?**

- 1. Export of non-taxable goods**
  - **Alcoholic Liquor for home consumption**
  - **Petrol, Diesel, etc.**
  
- 2. Export of exempted goods**
  - **Electricity**
  - **Other exempted goods or services**

## **B. Export of goods for consignment sale or exhibition purposes?**

## **C. Supplies to SEZ: Unjust Enrichment?**

- **Amendment in Section 54 w.e.f 01.02.2019**

## **D. Rule 96B : Receipt of Forex for export of goods**

- **Newly inserted w.e.f 23.03.2020**
- **Prospective or Retrospective**



# CASE STUDIES – HO/BO/LO Transactions



Tattvam Advisors Copyright

# Intra state Supply – Section 8

## Explanations to section 8

*Explanation 1.*—For the purposes of this Act, where a person has,—

- i. an establishment in India and any other establishment outside India;
- ii. an establishment in a State or Union territory and any other establishment outside that State or Union territory; or
- iii. an establishment in a State or Union territory and any other establishment registered within that State or Union territory,

then such establishments shall be treated as establishments of distinct persons.

*Explanation 2.*—A person carrying on a business through a branch or an agency or a representational office in any territory shall be treated as having an establishment in that territory.

### Case 1



# Supplies between Related/Distinct persons

## Common Trademark (E.g. TATA, Reliance)

Whether trademark registered in the name of holding company and used by various subsidiary or associate company be regarded as supply of services by holding company to subsidiary or associate company?

## Common Infrastructure

It basically includes sharing of infrastructure/resources with the other party. Example: Accounting for all the branches being done at HO etc.

## Common Management

Executives and management working for the entity as a whole be considered as provision of services between two related persons/distinct persons

## After sale services provided by branches

Goods supplied by the head office to customers across India whilst warranty services are provided by the branches located in respective states. In this case, whether services have been supplied by branches to head office?

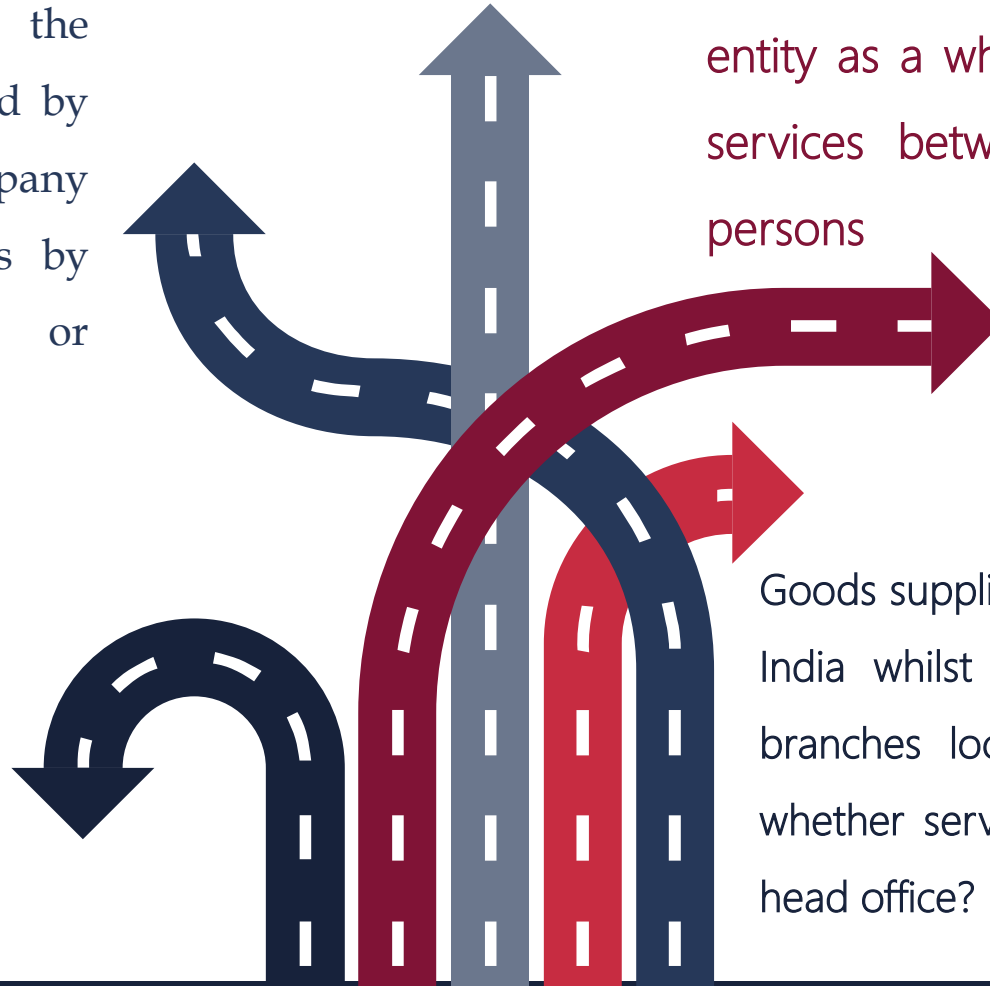

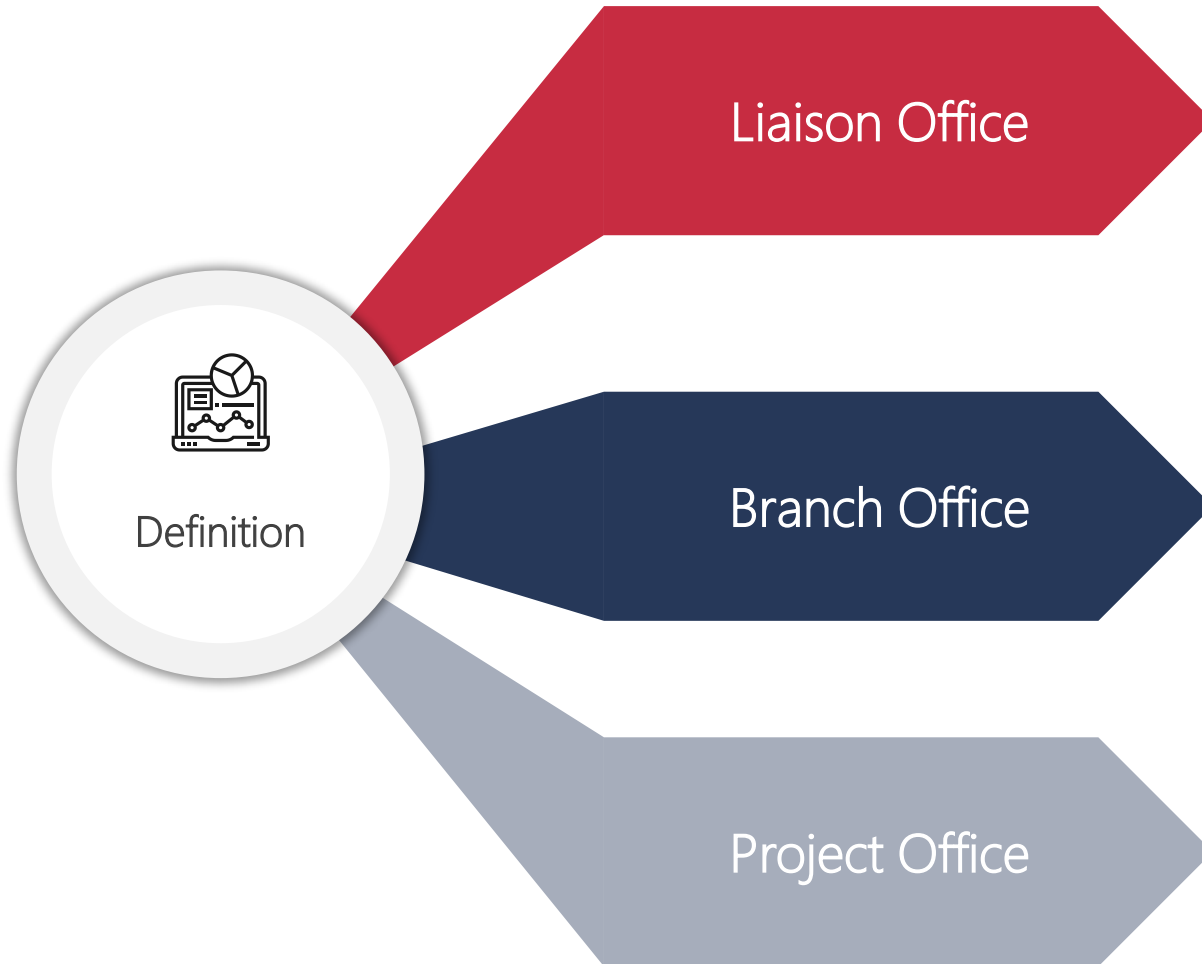

## Regulation 2(e) of FEMA Regulation

Place of business to act as a channel of communication between the principal place of business or Head Office or by whatever name called and entities in India but which does not undertake any commercial /trading/ industrial activity, directly or indirectly, and maintains itself out of inward remittances received from abroad through normal banking channel.

## Regulation 2(d) of FEMA Regulation

Branch Office in relation to a company means any establishment described as such by the company

## Regulation 2(f) of FEMA Regulation

Place of business in India to represent the interests of the foreign company executing a project in India but excludes a Liaison Office.





Notification No. 15/2018 – Integrated Tax (Rate) dated 26.07.2018, “services supplied by an establishment of a person in India to any establishment of that person outside India, which are treated as establishments of distinct persons in accordance with Explanation I in section 8 of the IGST Act”

## Reimbursement of expenses of Liaison Offices in India from a resident outside India

A company incorporated outside India establishes a liaison office in India subject to FEMA regulations. Pursuant to such regulations, liaison office shall not undertake any commercial/trading/industrial activity either directly or indirectly. The liaison office periodically receives remittances from head office to meet its recurring expenses such as salary, rent etc. Now, the question arises whether such remittance amounts to supply for a consideration or the argument that such remittances is not consideration but only funds for payment of salary/reimbursement of expenses would hold good?

Reference must be also made to advance rulings pronounced on above subject.

***M/s. Habufa Meubelen B. V. (Indian Liaison Office) dated 16.06.2018*** held that “*when the liaison office is working as per the terms and conditions as mentioned in FEMA regulations, the reimbursement of expenses and salary paid by head office to the liaison office, is not liable to GST, as no consideration for any services is being charged by the liaison office..*”

***M/s. Takko Holding GmbH dated 27.09.2018*** said that liaison office works as employees of foreign office and none of the activities of liaison office is covered under the definition of service and therefore not liable to GST.

## European Union law - various decisions - analysed the terms 'fixed establishment' for Place of Supply Rules

### *M/s. Gunter Berkholz vs. Finanzamt Hamburg-Mitte-Altstadt (Case 168/84)*

- Assessee was operating gaming machines on ferry boats plying between Germany and Denmark and had their main place of business at an office in Hamburg (Germany). The machines were maintained intermittently on the ships by their staff, but there were no permanent staff on board. The appellant argued that supplies were made on the ferry boats as a fixed establishment.
- **ECJ held that** 'Fixed Establishment' means an establishment, other than the business establishment, from which the activities of the organization are carried out and which has the permanent presence of both the human and technical resources necessary for making or receiving the supplies of services in question.

### **S. 2(50) or S. 2(7)**

- A place other than the registered POB
- Sufficient degree of permanence and suitable structure
- Human and technical resources to supply services

- Commissioners of Customs and Excise v. DFDS A/S [C-260/95]
- Aro Lease BV v. Inspecteur Der Belastingdienst Grote Ondernemingen Amsterdam
- Ral (Channel Islands) Ltd., RAL Ltd., RAL Services Ltd., RAL Machines Ltd. v. Commissioner of Customs and Excise
- Lease Plan Luxembourg SA v. Belgian State
- Heger Rudi GmbH v. Finanzamt Grax-Stadt
- HM Revenue and Customs v. Zurich Insurance Company

# Constitutional validity of service to distinct person

## Indian Association of Tour Operators v. Union of India

Article 269A provides that Goods and Services Tax on supplies in the course of inter-State trade or commerce shall be levied and collected by the Government of India. Further, Article 269A(5) provides that Parliament may, by law, formulate the principles for determining the place of supply, and when a supply of goods, or of services, or both takes place in the course of inter-State trade or commerce.

Article 286 (1) has been amended to provide that no law of the state shall impose tax on supply of goods or service when such supply takes place in the course of export of service outside the territory of India.

Further, Article 286 (2) of the Constitution of India has been amended simultaneously to provide that Parliament may by law formulate the principles to determine when an export of services takes place in any of the ways mentioned in Article 286 (1).

Thus, the Constitution itself empowers the Parliament to determine what constitute an inter-state supply and export of service. There are no fetters to this power of the Parliament and it is well within its rights to impose Goods & Service Tax on any supply which it determines to be an inter-state supply.



# Airline Industry

# Case Study - Airline Industry

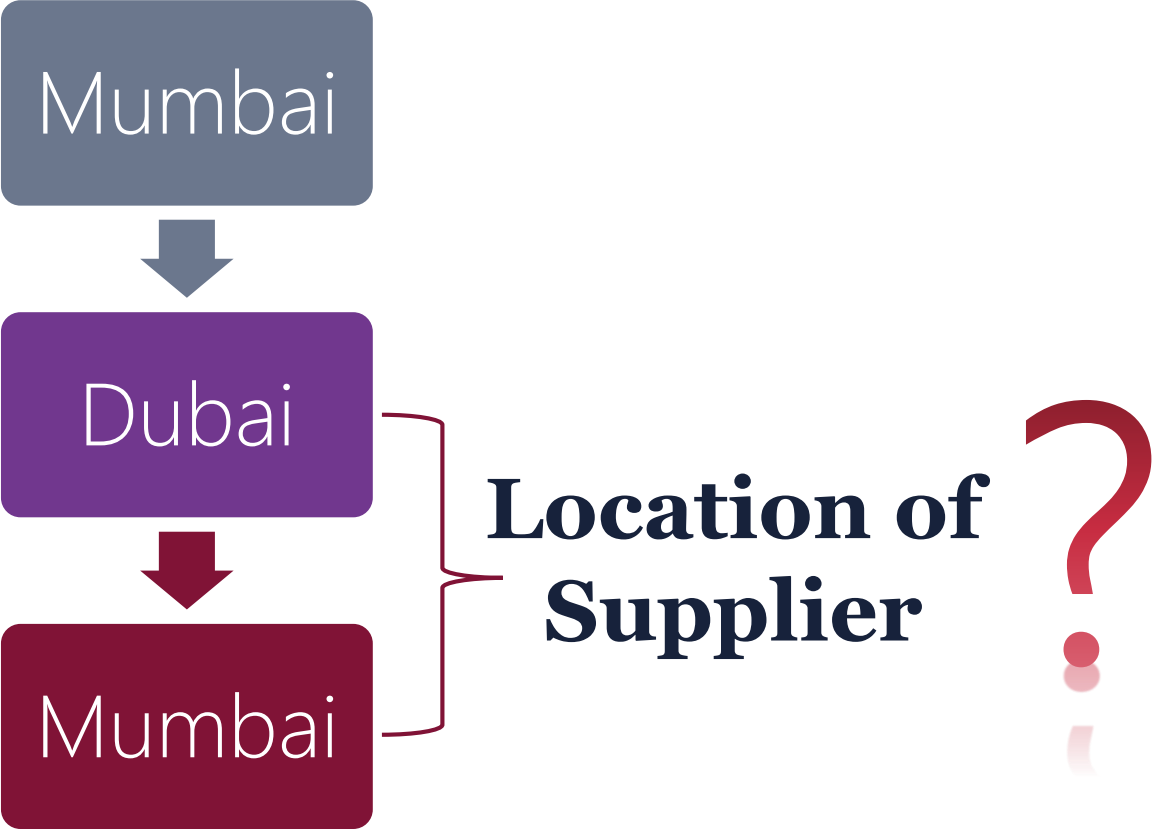

## Section 12(9)

The place of supply of **passenger transportation** service to,—

(a) a **registered person**, shall be the **location of such person**;

(b) a person other than a registered person, shall be the place where the passenger **embarks on the conveyance for a continuous journey**:

Provided that where the right to passage is given for future use and the point of embarkation is not known at the time of issue of right to passage, the place of supply of such service shall be determined **in accordance with the provisions of sub-section(2)**.

*Explanation. —For the purposes of this sub-section, the return journey shall be treated as a separate journey, even if the right to passage for onward and return journey is issued at the same time.*

## Section 13(10)

The place of supply in respect of passenger transportation services shall be the place where the passenger embarks on the conveyance for a continuous journey.



# Cross Border Transportation of Goods

---



## Cross border transportation

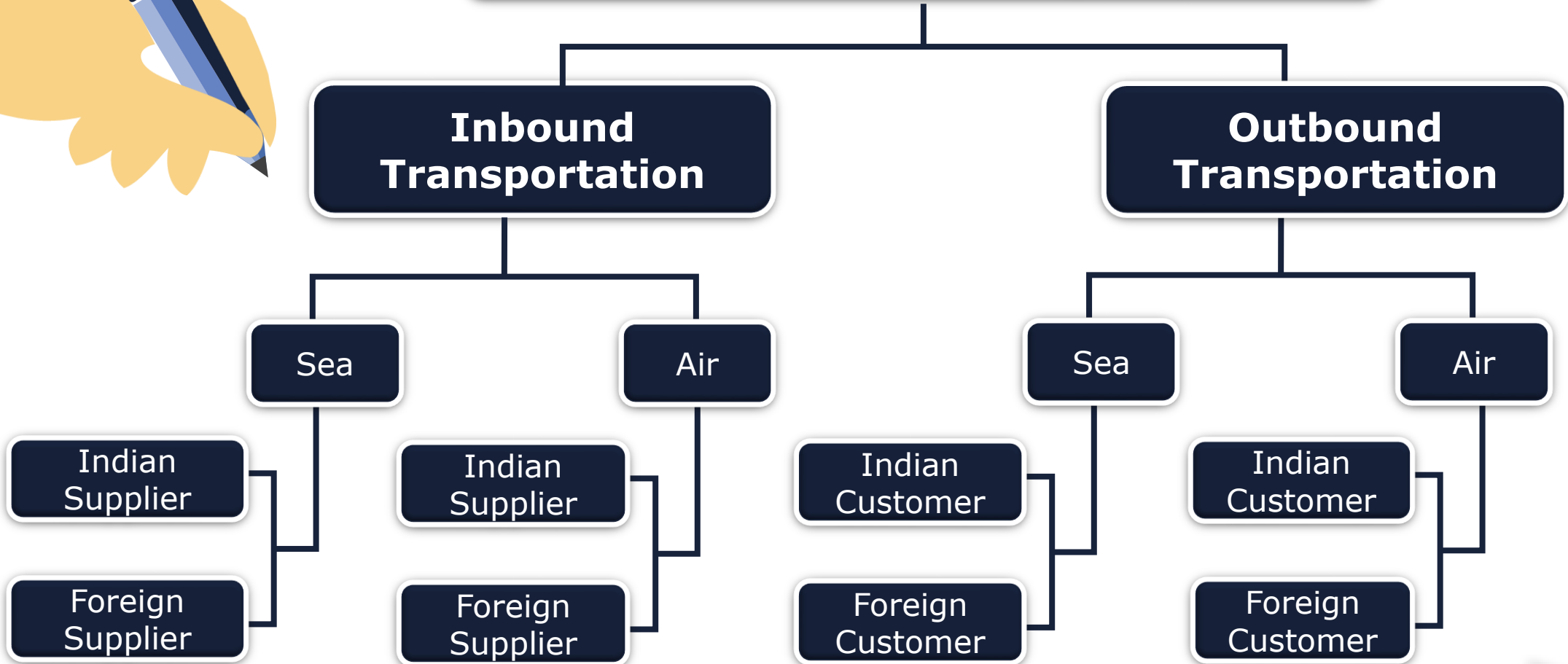

## Scenario

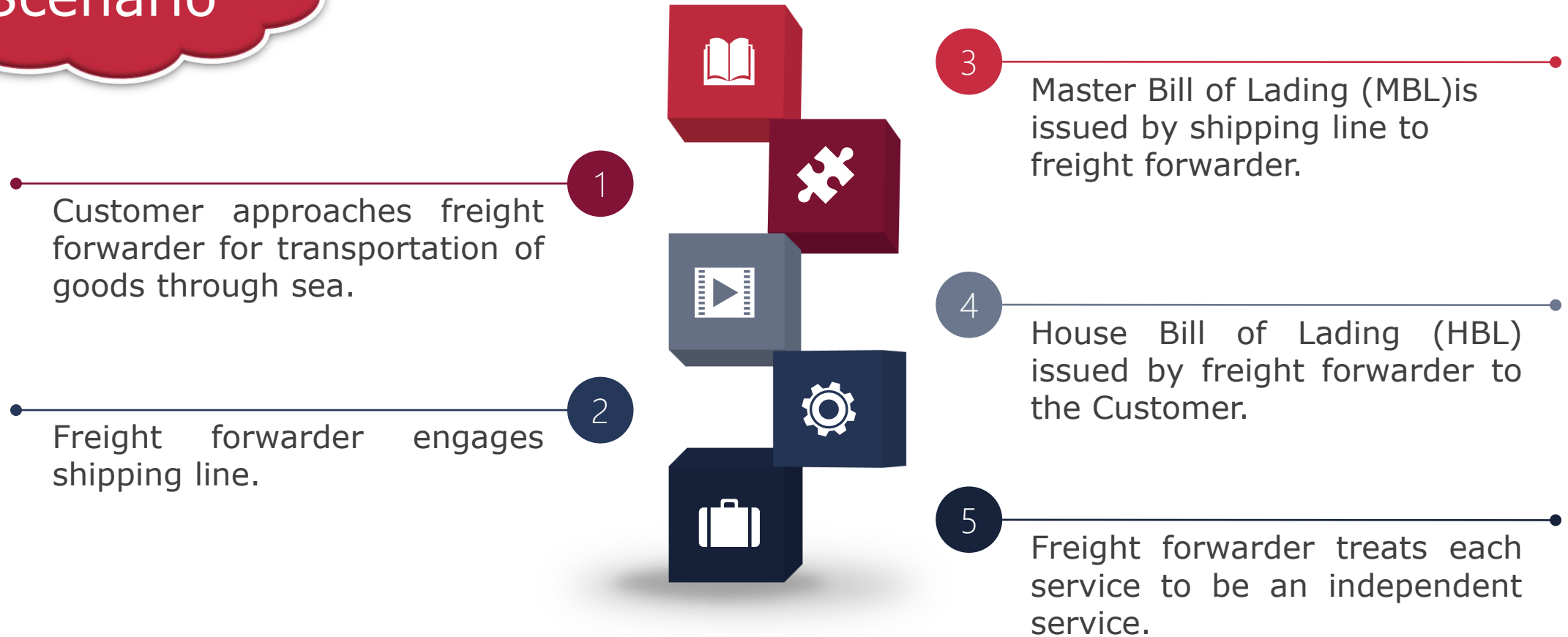

## Our Comments

S. No	Charges	Customer	Place of Supply	SAC Codes	Taxability
1.	<b>Ocean Freight</b>	Indian Customer	Outside India [Section 12(8)]	9965	<b>No Tax (Exempt)</b> ➤ Exemption available only up to 30 <sup>th</sup> September 2019.
		Foreign Customer	Outside India [Section 13(9)]		
2.	<b>Transportation by Road within India</b>	Indian Customer	India [Section 12(8)]	9965	<b>No Tax (Exempt)</b> ➤ Assumed freight forwarder is not a GTA who issues Consignment Note ➤ Transportation of goods by road other than by GTA is exempt.
		Foreign Customer	India [Section 13(9)]		

S. No	Charges	Customer	Place of Supply	SAC Codes	Taxability
3.	<b>Terminal Handling Charges in India</b>	Indian Customer	India [Section 12(2)]	9967	<b>Taxable @ 18%</b>
		Foreign Customer	India [Section 13(3)(a)]		<b>Taxable @ 18%</b> ➤ It shall not qualify to be export of services even if payment is received in foreign currency for the reason place of supply of such service shall be in India.
4.	<b>Customs Clearance Charges in India</b>	Indian Customer	India [Section 12(2)]	9967	<b>Taxable @ 18%</b>
		Foreign Customer	Outside India [Section 13(2)]		<b>Taxable @ 18%</b> ➤ However, such service would qualify to be export of service if payment is received in foreign currency and other conditions provided under Section 2(6) of the IGST Act is fulfilled.

S. No	Charges	Customer	Place of Supply	SAC Codes	Taxability
5.	<b>DO Charges</b>	Indian Customer	India [Section 12(2)]	9967	<b>Taxable @ 18%</b>
		Foreign Customer	Outside India [Section 13(2)]		<b>Taxable @ 18%</b> ➤ However, such service would qualify to be export of service if payment is received in foreign currency and other conditions provided under Section 2(6) of the IGST Act is fulfilled.
6.	<b>Terminal Charges India</b>	<b>Handling outside</b>	Such services would be provided outside India by foreign affiliate to foreign consignee. Accordingly, invoice for said services shall also be raised by foreign affiliate on the customer. Such transaction would not attract any tax implication in the hands of freight forwarder.		
7.	<b>Customs Charges India</b>	<b>Clearance outside</b>			



## Our Comments

S. No	Charges	Customer	Place of Supply	SAC Codes	Taxability
1.	<b>Ocean Freight</b>	Indian Customer	Outside India [Section 12(2) of the IGST Act, 2017]	9965	<p>The nature of services provided by freight forwarder is basically facilitating supply of services between the customer and freight forwarder. Hence, any commission charged by freight forwarder for the said service shall be subject to levy of GST.</p> <p><b>Indian Customer:</b> if the location of freight forwarder and customer is in the same State, freight forwarder shall charge CGST plus SGST. However, if it is in different State, freight forwarder shall charge IGST.</p> <p><b>Foreign Customer:</b> Freight forwarder shall charge CGST plus SGST.</p>
		Foreign Customer	Outside India [Section 13(8)(b) of the IGST Act, 2017]		
2.	<b>Implications on</b> <ul style="list-style-type: none"> <li>➤ <b>Handling charges at Indian Port</b></li> <li>➤ <b>Custom clearance charges in India</b></li> <li>➤ <b>DO Charges</b></li> </ul>	<ul style="list-style-type: none"> <li>• Implications same as discussed in previous scenario.</li> </ul>			

```
mirror_mod = modifier_ob.  
#set mirror object to mirror_  
mirror_mod.mirror_object =  
_operation == "MIRROR_X":  
mirror_mod.use_x = True  
mirror_mod.use_y = False  
mirror_mod.use_z = False  
_operation == "MIRROR_Y":  
mirror_mod.use_x = False  
mirror_mod.use_y = True  
mirror_mod.use_z = False  
_operation == "MIRROR_Z":  
mirror_mod.use_x = False  
mirror_mod.use_y = False  
mirror_mod.use_z = True  
  
#selection at the end -add  
mirror_ob.select= 1  
modifier_ob.select=1  
context.scene.objects.active  
("Selected" + str(modifier_ob.  
rc = 0) + ".cf")  
by = context.scene.objects[  
at = objects[0].name  
print("please select exactly  
-- OPERATOR CLASSES --  
  
types.Operator):  
X mirror to the selected  
object.mirror_mirror_x"  
mirror X"  
  
context):  
context.active_object is not
```

# SOFTWARE INDUSTRY





## Modes of Importation

1. Software (including License Key) imported through electronic medium
2. Software (including License Key) imported through physical medium
3. Software imported through electronic medium and License Key imported through physical medium or vice versa



**Whether Software is Goods or Services?**

**Whether software qualifies as IPR?**

**Whether dual levy?**

## As Goods

- Proviso to Section 5 of IGST Act: Import of Goods
- Tata Consultancy Services vs State Of Andhra Pradesh – SC 2004
- CTH 4907 00 30: Documents of title conveying the right kg. 10% - to use Information Technology software – **IGST 12%**
- CTH 8523 80 20: - Information technology software - **IGST 18%**
- S. No. 298 of NN 50/2017-Custom. **Exemption of BCD**

## As Services

- Schedule II treat as services
  - 5(c): Temporary transfer or permitting the use or enjoyment of any intellectual property right
  - 5(d): Development, design, programming, customisation, adaptation, upgradation, enhancement, implementation of information technology software;
- **GST – 18%** (S. No. 17(ii) of NN 8/2017-IGST)
- **Specific exemption** under NN 8/2018-IGST

## Exemption of IGST on the supply of services, imported into the territory of India,

- covered item **5(c) of Schedule II**
- **to the extent of** the aggregate of the duties of Customs leviable under section 3(7) of the Customs Tariff Act, 1975
- on the **consideration declared under section 14(1)** of the Customs Act, 1962 towards royalties and license fees included in the transaction value
- as specified under rule 10(1)(c) of the Customs Valuation (Determination of Value of Imported Goods) Rules, 2007
- on which the appropriate duties of Customs have been paid.

## **Exemption of BCD on**

- (i) Information Technology software, And
- (ii) Document of title conveying the right to use Information Technology software.

*Explanation.- “Information Technology software” means any representation of instructions, data, sound or image, including source code and object code, recorded in a machine readable form, and capable of being manipulated or providing interactivity to a user, by means of an automatic data processing machine.*



# Special Economic Zone (SEZ)

---



## Inter-State Supplies

- Section of IGST Act
- Supply to SEZ unit or developer
- Supply by SEZ unit or developer

## Section 26 of SEZ Act

- Exemption, drawback and concession to SEZ unit or developer
- **GST not specified**

## Section 30 of SEZ Act

- Goods removed to DTA chargeable to duty of custom

## Zero-Rate Supplies

- Supply to SEZ unit or developer

## Overriding effect of SEZ Act

- Section 51
- SEZ Act have overriding effect with other consistent laws

## Tax Implications

### **S. 5 & 16 of IGST Act**

- Inter-State Supplies &
- Zero Rated Supplies

On 18-09-2018 an amendment was brought to sub-rule 4 of the Rule 30 of SEZ Rules vide SEZ (Amendment) Rules, 2018 which mandated the AOs/SOs to certify such supply Invoices

### **Supplies with payment of GST**

- Refund claim by DTA supplier
  - Unjust enrichment?
  - Rule 96B?
- Whether ITC can be availed by SEZ?
- Both available – Whether any restriction?

### **Supplies without payment of GST**

- Refund of unutilized ITC by DTA?

## Benefits?

**Advance Authorization**

**EPCG Scheme**

**All India Duty rate of Duty Drawback**

## Discussion Areas

- 1. Is SEZ part of India for GST purposes?**
- 2. What is Authorized Operations**
  - What is authorized operations?
  - Whether zero-rated only if authorized operations? – Section 51 of SEZ Act
  - Examples such as hotel accommodation, etc.?
- 3. Excise Duty Exemption?**

- Section 2(b) of SEZ Act defines “authorised operations” to mean operations which may be authorized under sub-Section (2) of Section 4 and sub-section (9) of Section 15.
- Section 15(9) provides that the Development Commissioner may, after approval of the proposal referred to in sub-section (3), grant a letter of approval to the person concerned to set up a Unit and undertake such operations which the Development Commissioner may authorise and every such operation so authorised shall be mentioned in the letter of approval.



# Authorized operations (AO) of SEZ?

- Refund available only when supplies used by SEZ for its AOs;
- Refund application should be accompanied by the endorsement of specified officer that goods/services have been received for use in AO;
- In Service tax, 'default list of services' issued by Deptt. of Commerce in respect of which service tax was exempted. List made applicable to GST also.
- **No requirement of 'use for authorised operations' in IGST Act?**
- **Whether authorised operations necessary to supply under LUT?**

# Services of hotel to SEZ employees?



Hotel in DTA

- Accommodation service to employees of SEZ.
- Invoice in the name of SEZ

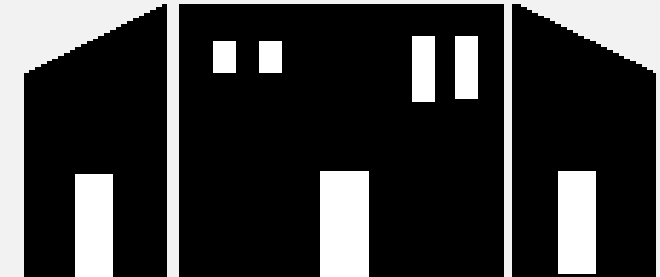

**Section 7(5):** Inter-state  
**SEZ order:** Deemed authorized operations  
**Contradictory AAR**

**DTA**

**SEZ**

**GOVERNMENT OF INDIA  
MINISTRY OF COMMERCE & INDUSTRY  
DEPARTMENT OF COMMERCE  
(SEZ SECTION)**

**New Delhi: 02.01.2018**

*To  
All Development Commissioners  
Special Economic Zone*

**Subject: Uniform list of services to be followed in SEZs - Reg.**

I am directed to refer to this Ministry's letter No. D.12/25/2012-SEZ dated 16th September, 2013 and subsequent letters of even number dated 19th November, 2013, 19th June, 2014 and 9th July, 2014 vide which a list of 66 services which may be permitted by all Unit Approval Committees (UACs) as default authorised services was conveyed (copies enclosed).

2. The BoA was appraised that consequent to implementation of GST Act, some State Government are not extending the benefits of IGST exemption for default services. Since, SEZs are exempt from IGST and the above matter was placed before 80\* BoA meeting held on 17th November, 2017. The BoA, after deliberations, approved the reiteration of the default authorized operations as approved, earlier.

Encl: Annexure - List of 66 services. **ACCOMODATION SERVICE COVERED UNDER LIST**

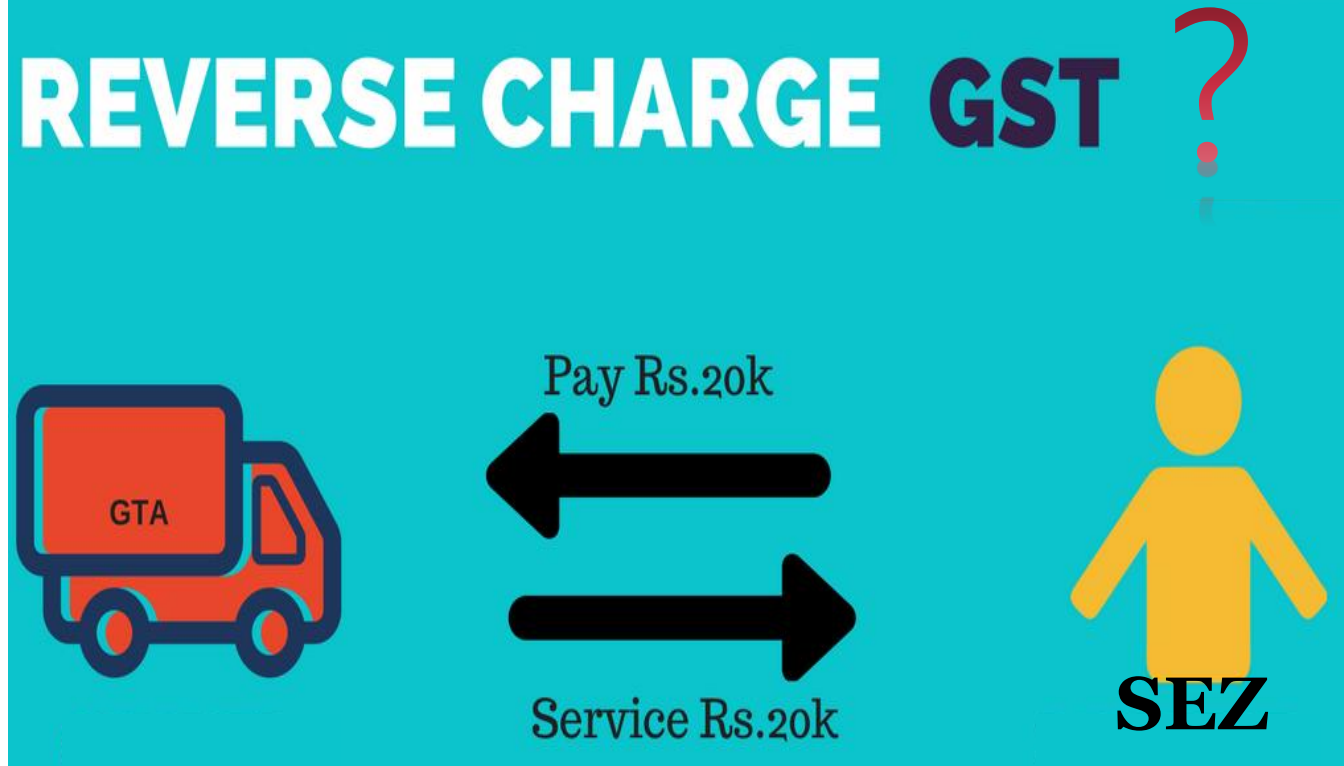

## Tax Implications

### Section 5(3)

The Government may, on the recommendations of the Council, by notification, specify categories of supply of goods or services or both, the tax on which shall be paid on reverse charge basis by the recipient of such goods or services or both and ***all the provisions of this Act shall apply to such recipient as if he is the person liable for paying the tax in relation to the supply of such goods or services or both.***

**Whether services received by SEZ specified in RCM list can be said to be zero-rated supplies?**

## Import by SEZ

- Import of Goods – Exemption or no levy
- Import of services – Exemption or no levy?

## SEZ to customer outside India

- Zero-rated supplies?
- Refund of unutilized credit?
- MEIS & SEIS
- Travel and Marketing Assistance (TMA)
- Interest Subvention Scheme

## SEZ to DTA

### Goods

- Section 30 of SEZ Act – What is duty of custom?
- BCD and IGST both payable?
- Who is liable to pay-SEZ or DTA customer?
- BCD through Bill of entry for Home consumption?
- IGST through Tax Invoice?

### Services

- Import of Services and RCM Liability? or
- Tax Invoice raised by SEZ?

# EOU

---



# Export Oriented Undertakings

Introduced in 1981

To Increase export, forex earnings and employment

EOU/STP/EHTP/BTP are together called the EOU scheme.

Chapter 6 of Foreign Trade Policy 2015-20

GST Law: Deemed export as per S. 147 of CGST Act read with NN 48/2017-CT

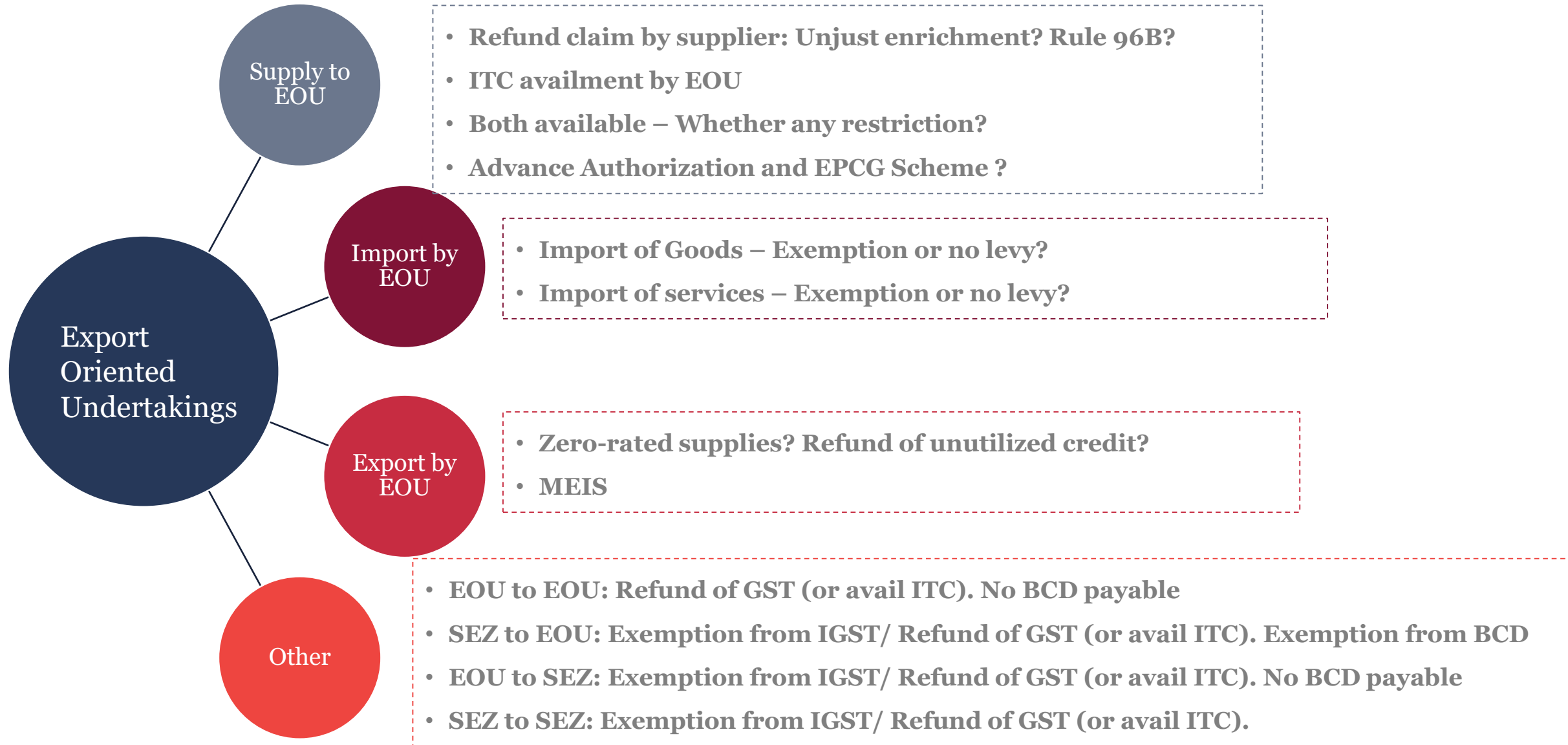



# Free Trade and Warehousing Zone (FTWZ)



Tattvam Advisors Copyright

**Section 2(n) of SEZ Act** defines FTWZ as a SEZ wherein mainly trading and warehousing and other activities relating thereto are carried on.

**Rule 18(5) of Special Economic Zone Rules, 2006** allows the units in FTWZ or units in FTWZ set up in other SEZ to hold goods on account of the foreign supplier for dispatches as the owner's instructions and shall be allowed for trading with or without labelling or repacking without any processing

## Facts

- FTWZ receives goods from a foreign client for undertaking authorised operation.
- Warehousing and other value added services.
- Services performed within the FTWZ itself.
- On completion of services, the goods may either be removed to DTA or exported outside the country

## Supply to FTWZ

### Section 16 of IGST Act

- Zero-rated supplies?
- **Export of services by DTA?**
- **Import of Services by FTWZ**

## Supply by FTWZ

### Foreign Customers

- S. 13(3)(a) of IGST Act: Services in respect of goods required physically. POS- Place of performance
- Section 13(9) of IGST: POS -Destination of Goods
- **Export of services?**

### DTA Customers

- S. 12(2) of IGST Act: General Rule. POS- Location of registered recipient
- Section 12(8) of IGST: Transportation Services. POS - Location of registered recipient
- **Export of services?**

# THANK YOU



Delhi Office: JD-2C, 2nd Floor,  
Pitampura, Near Pillar No. 355, New  
Delhi, Delhi 110034

Gurgaon Office: Plot No. 508, Sector-  
40, Gurugram, Haryana, 122003.

Email:  
[tushar.aggarwal@tattvamadvisors.com](mailto:tushar.aggarwal@tattvamadvisors.com)

Website: [www.tattvamadvisors.com](http://www.tattvamadvisors.com)

Contact: 9953107107

## TEAM TATTVAM ADVISORS

FIGHT AGAINST COVID-19

